



# ADVANCED AQUACULTURE SYSTEMS

SUSTAINABLE FISH FARMING

COMPANY PROFILE, RAS PROJECTS  
& FEATURED EQUIPMENT

**VIEW THE LATEST VERSION  
OF THIS CATALOG ONLINE**





## DOCUMENT INDEX

SECTION	PAGE
COMPANY PROFILE	6
REFERENCES	8
OFFICES & TEAM	10
PROTEIN SKIMMERS & NIVA TEST RESULTS	12
OZONE GENERATORS	24
BACKFLOW PREVENTION	40
DRUM FILTERS	42
UV DISINFECTION UNITS	56
MBBRs	64
TRICKLE FILTERS & DEGAS TOWERS	70
OVERFLOW LAUNDERS	86
FOAM EXTRACTORS	88

SECTION	PAGE
OZONE DESTRUCT SYSTEMS	90
OZONE CONTACT & OZONE DOSING SKIDS	100
PMF SKID SYSTEMS & FILTER TANKS	110
PUMP STRAINERS	120
STATIC SCREEN FILTERS	124
SKID FILTRATION UNITS	128
TANKS & QUARANTINE SYSTEMS	138
LIVE FEED PRODUCTION SYSTEMS (ARTEMIA, ROTIFERS, COPEPODS)	142
OXYGEN CONES	146
DAF	150
RADIAL FLOW SETTLERS	160
GATE VALVES	164

# MAT-KULING COMPANY PROFILE

MAT-KULING AS is a Norwegian firm, which focuses on RAS (Recirculating Aquaculture Systems), and industrial filtration equipment & technology, providing innovative solutions to



EGEMAR SEA BREAM & SEA BASS HATCHERY

intensive land based fish farming.

Working closely with aquaculture industry leaders and universities, we design & fabricate the most updated RAS filtration technology.

MAT-KULING RAS Technology offers equipment, customized to each project, aiming to



SWISS LACHS LAND BASED SALMON FARM



## Proven Norwegian RAS Technology

LA FERME PISCICOLE DES BOBINES RAINBOW TROUT

increase the production capacity, & eventually sustainable operations.

In MAT-KULING we thrive to design and supply RAS equipment to secure maximum available biosecurity whilst maintaining sustainable production and operation costs.



NORDZEE SEA BREAM & SEA BASS HATCHERY

We provide efficient RAS technology for closed circuit fish farming & our experienced aftersales team provides onsite 24/365 support, physically and online.

Our RAS technology, comes with 5 years warranty using MEP components made in EU &



AKVATEK SEA BREAM & SEA BASS HATCHERY

USA & we operate under ISO 14001 and 9001 protocols, carrying VIT, UL, SASO, EUOTA, and CE.

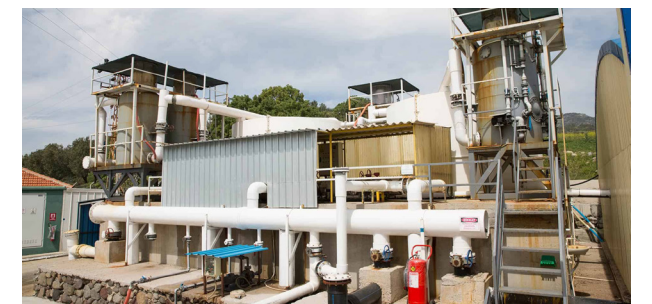

ILKNAK SEA BREAM HATCHERY



### Biosecurity Meets Intensive Fish Farming



For more information about MAT-KULING please visit our website at [matkuling.com](http://matkuling.com)



## THEY TRUST MAT-KULING

Eyvi

جامعة الملك عبدالله  
للعلوم والتقنية  
King Abdullah University of  
Science and Technology



## MAT-KULING OFFICES

### MAT-KULING HEADQUARTERS

- » Address: Kvitsøygaten 10, 4014, Stavanger, **Norway**
- » Phone: (+47) 90 86 53 01
- » Email: info@matkuling.no
- » Contact Person: Bjørn Dørum

### MAT-KULING NORDIC COUNTRIES

- » Address: Prestanesvegen 27, 5392 Storebø, **Norway**
- » Phone: (+47) 468 55 274
- » Email: kk@matkuling.no
- » Contact Person: Kjetil Kolbeinsvik

### MAT-KULING CENTRAL EUROPE

- » Address: Hattersheimer 26, 60326, Frankfurt am Main **Germany**
- » Phone: (+47) 468 55 274
- » Email: kk@matkuling.no
- » Contact Person: Kjetil Kolbeinsvik

### MAT-KULING USA

- » Address: **USA**
- » Phone: (+47) 90 86 53 01
- » Email: sales@matkuling.no
- » Contact Person: Bjorn Dorum

### MAT-KULING MIDDLE EAST

- » Address: Concord Tower, ABC Business Center, Floor 6 Office 601-30, POB 126732, Media City, Dubai, **UAE**
- » Phone: (+971) 50 644 6691
- » Email: ne@matkuling.no
- » Contact Person: Nurettin Ersu

Contact MAT-KULING today to meet people that understand your concerns in the aquaculture industry. We welcome any request seeking for intensive aquaculture filtration solutions. We understand your needs and we will make the extra step to serve you in the best possible way. We aim for continuous long lasting business relation with all our clients and friends around the world.

## THE TEAM



**BJØRN DØRUM**  
Chairman



**TANER BILGIC**  
General Manager & CTO



**NURETTIN ERSU**  
Country Manager UAE, KSA, Bahrain



**OKAY ATIS**  
Domestic Sales & Business Development Manager



**AYNUR KESER**  
Technical Sales Manager

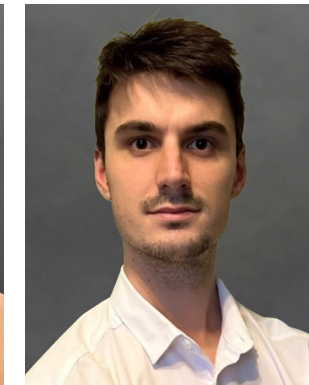

**VIT WOLF PROFANT**  
Aquaculture Team Leader



**NIL LLONCH LLUSSA**  
M.Sc. RAS Specialist & Biologist



**KJETIL KOLVBEINSVIK**  
Country Manager Norway



# NIVA (NORWEGIAN INSTITUTE FOR WATER RESEARCH) RESULTS

The Norwegian Institute for Water Research (NIVA), Norway's leading Non For Profit Institute for fundamental and applied research on marine and freshwaters. NIVA's world-class expertise is multidisciplinary with a broad scientific scope.

NIVA officials, performed an independent, nonpaid field trial on MAT-KULING's freshwater protein skimmer performance in an undisclosed salmon farm facility in Norway. The trial occurred between 12.08.2020 and 10.09.2020.

NIVA collected water samples before the installation of MAT-KULING freshwater skimmer and continued collecting samples after the installation of the Protein Skimmers for about 1 month.

During the trial the pre-smolt pool was operated in full capacity and following the

standard farming protocol.

The results as they can be observed on the diagrams presented, were better than expected.

There was significant removal in small, medium and large particles. This resulted in improvement in several water quality chemical parameters.

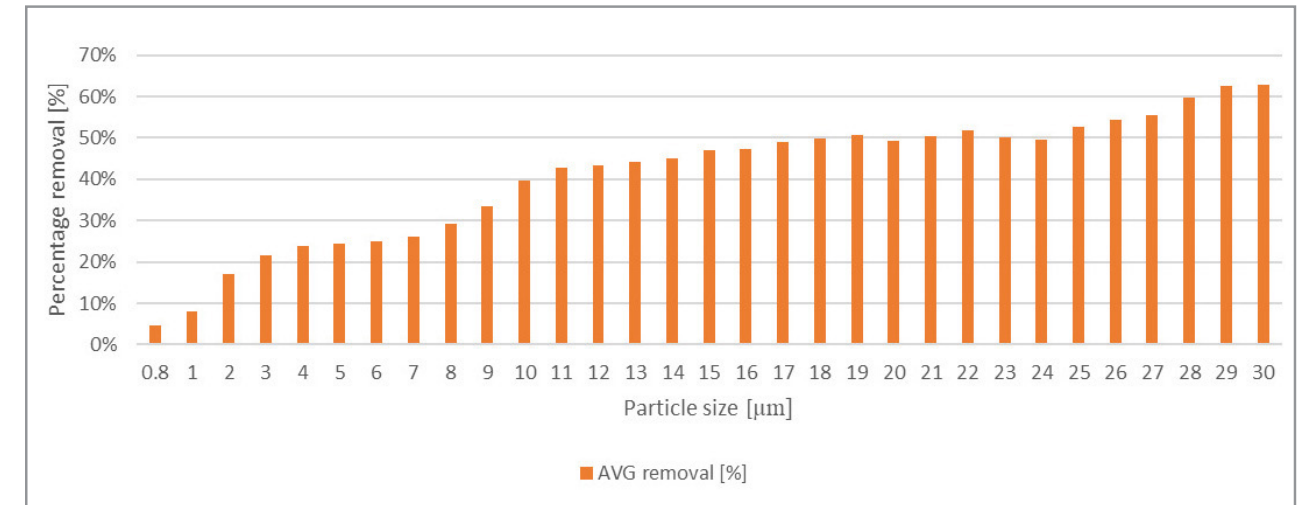
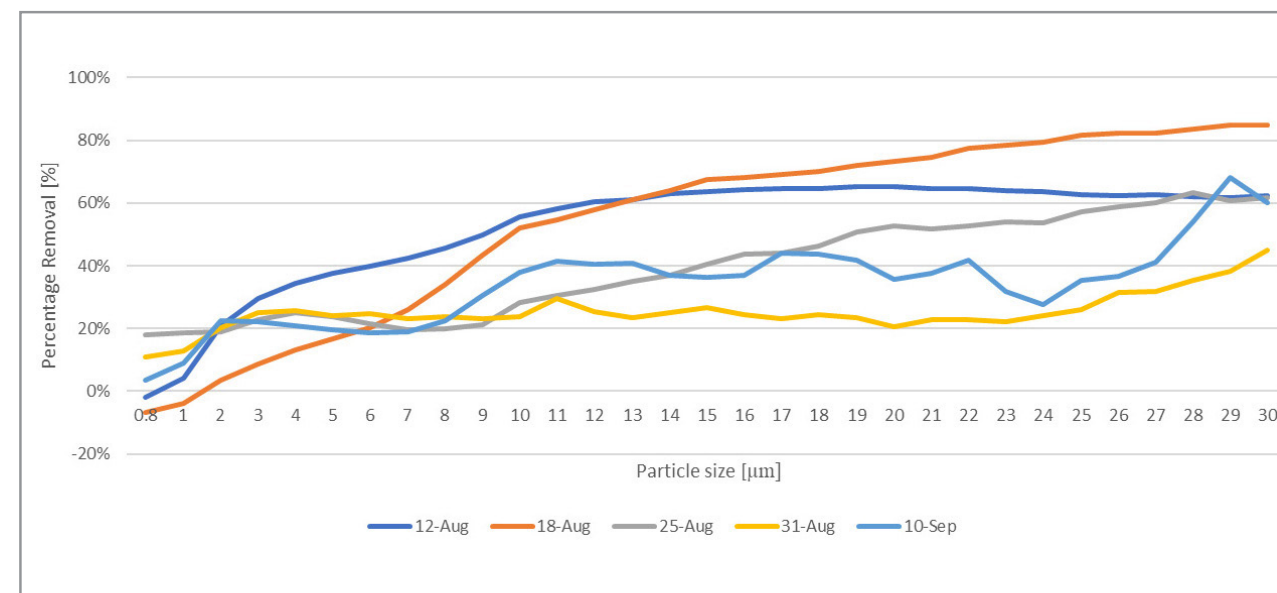



# MARINE & FRESHWATER PROTEIN SKIMMERS

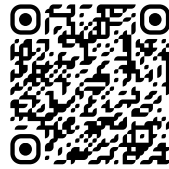

The Protein Skimmers / Foam Fractionators are used to provide an efficient means of floatable and dissolved solids control, by removing mechanically, fine and dissolved organics from water. A combination of a Protein Skimmer and Ozone generator is a perfect choice to increase the production capacity of the current facilities by UVT & Turbidity & COD treatment simultaneously by killing free-swimming bacteria and oxidation of a dissolved substance.

Additionally, through the fractionation process, the MAT-KULING Foam Fractionator infuses oxygen and ozone that minimize bacteria and microorganisms and

maximise O2 concentration in Recirculated Aquaculture Systems (RAS). User-friendly operation.



# CONCRETE PROTEIN SKIMMERS

MAT-KULING can provide Protein Skimmers set-ups for concrete chambers for larger RAS applications. Concrete Protein Skimmers can be more cost-effective solutions after 1000m<sup>3</sup>/h Protein Skimmer Flowrates compared to prefabricated units with their bodies.

It is not only the most CAPEX efficient but also the most OPEX efficient foam fractionation solution. Locating concrete protein skimmers chambers into the channel

flow sequence by the designer eliminates the feed pump and main energy requirement of Protein Skimmer application.

Our Design Team supports RAS Designers/Contractors technically for the sizing of concrete chamber and channels.

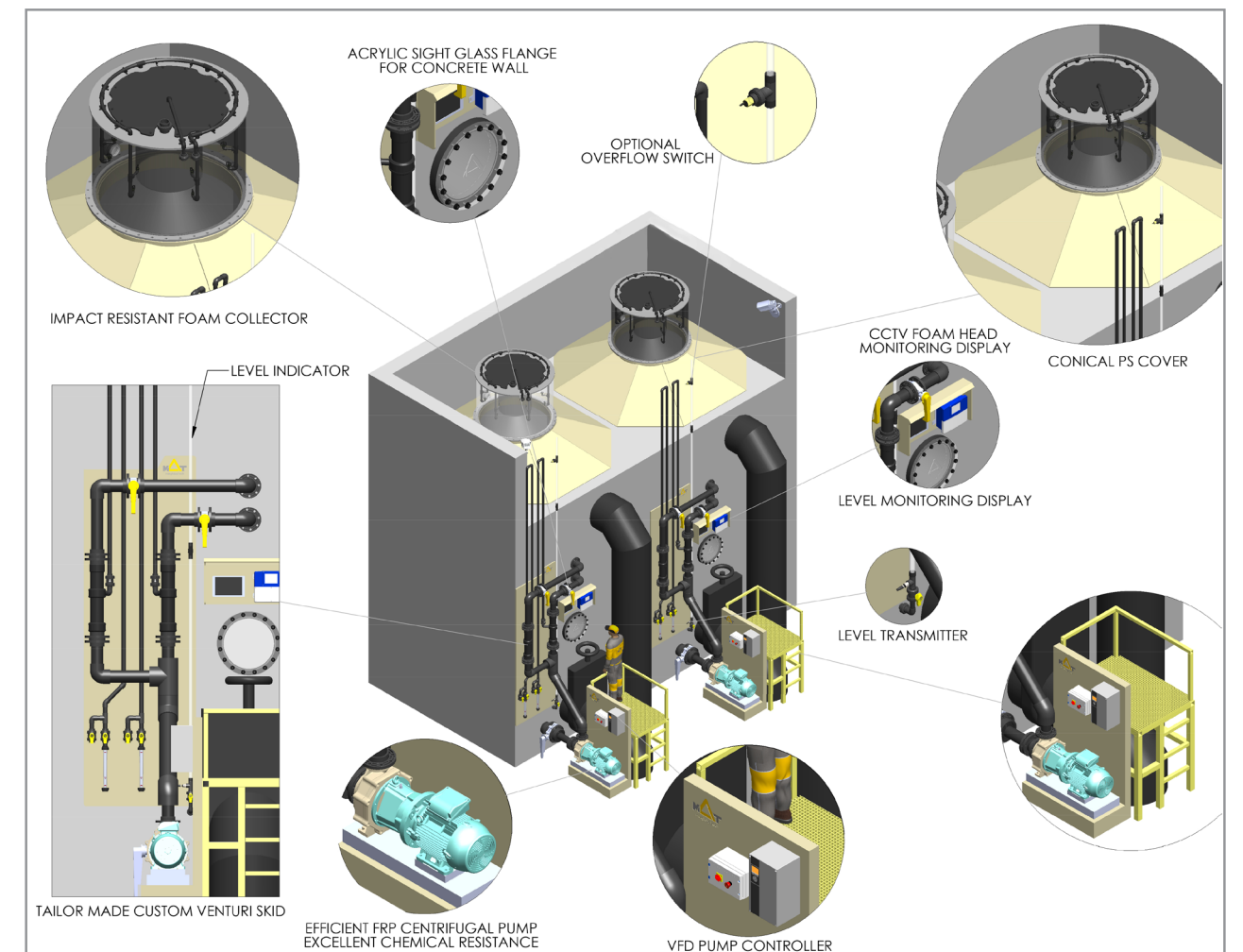



PROTEIN SKIMMER-M	PSM-14	PSM-22	PSM-62	PSM-220
Footprint Depth [mm]	800	975	1190	1700
Footprint Width [mm]	955	1195	1505	2400
Diameter [mm]	315	500	750	955
Height [mm]	1825	1929	2320	2670
Installed Power [kW]	0.45	0.68	0.71	0.97
Basic Unit Total Electric Consumption [kWh]	0.32	0.48	0.5	0.68
Supply Voltage (50Hz) [V]	3~400/230	3~400/230	3~400/230	3~400/230
Inlet Size [mm]	63	75	110	160
Inlet Qty [pcs]	1	1	1	1
Inlet Level [mm]	1196	1187	1500	1590
Outlet Size [mm]	75	90	140	225
Outlet Qty pcs	1	1	1	1
Outlet Level [mm]	1235	1227	1518	1585
Body Volume [m <sup>3</sup> ]	0.09	0.24	0.71	1.29
Minimum-Maximum operation water level [mm]	1275-1533	1353-1631	1705-2010	1949-2254
Foam Collector effluent connection size [mm]	50	50	50	63
Max Flow Rate [m <sup>3</sup> /hr]	15	22	62	220
Max flow Dwell Time [second]	22	38	41	21
@1 min Dwell Time Flow Rate [m <sup>3</sup> /hr]	5.4	14.4	42.6	77.4
@1.5 min Dwell Time Flow Rate [m <sup>3</sup> /hr]	3.6	9.6	28.4	51.6
@2 min Dwell Time Flow Rate [m <sup>3</sup> /hr]	2.7	7.2	21.3	38.7
Dry weight [kg]	82	102	160	254
Operational Weight [kg]	172	400	920	1650
Body Material	PP	PP	PP	PP
Venturi Pump Qty [pcs]	1	1	1	1
Venturi Pump Model	44/8	44/12	21-40/54H G	21-40/58H G
Nominal Air Suction [Nm <sup>3</sup> /hr]	2	2	4	6

PSM-280	PSM-360	PSM-600	PSM-800	PSM-1300	PSM-1500
1900	2100	3275	2900	3755	4185
2570	2800	3350	3810	3850	5435
1250	1500	2000	2350	3000	3400
3080	3630	3705	4600	4680	4825
1.9	3.45	4.5	7.5	11	15
1.3	2.52	3.33	5.5	8.8	12.35
3~400/230	3~400/230	3~400	3~400	3~400	3~400
200	225	315	400	500	630
1	1	1	1	1	1
1838	2300	2185	2700	2723	2593
250	280	315	400	500	630
1	1	1	1	1	1
1845	2259	2181	2560	2560	2560
2.74	4.5	8.09	14.5	23	29
2230-2605	2806-3156	2922-3372	3095-3305	3665-4065	3810-4210
63	63	90	90	90	90
280	360	600	819	1300	1500
35	45	49	42	64	70
164.4	270	485.4	870	1380	1740
109.6	180	323.6	580	920	1160
82	135	242.7	435	690	870
390	525	870	1100	1750	2070
3200	5300	9500	13500	25000	29000
PP	PP	PP	PP	PP	PP
1	1	1	1	1	1
21-50/43	21-81/33	21-81/34	CMO-N 65-125	CMO-N 65-160	CMO-N 65-160
18	23	32	45	70	90

PROTEIN SKIMMER-F	PSF-22	PSF-62	PSF-220	PSF-280
Footprint Depth [mm]	1195	1195	1400	1810
Footprint Width [mm]	1043	1525	2220	2550
Diameter [mm]	500	750	955	1250
Height [mm]	1927	2320	2670	3085
Installed Power [kW]	1.1	1.33	3.5	3.5
Basic Unit Total Electric Consumption [kWh]	0.75	1	3	3
Supply Voltage (50Hz) [V]	3~400/230	3~400/230	3~400/230	3~400/230
Inlet Size [mm]	75	110	160	200
Inlet Qty [pcs]	1	1	1	1
Inlet Level [mm]	1185	1500	1590	1838
Outlet Size [mm]	90	140	225	250
Outlet Qty [pcs]	1	1	1	1
Outlet Level [mm]	1252	1518	1585	1845
Body Volume [m <sup>3</sup> ]	0.24	0.71	1.29	2.74
Minimum-Maximum operation water level [mm]	1353-1631	1705-2010	1949-2254	2230-2605
Foam Collector effluent connection size [mm]	50	50	63	63
Max Flow Rate [m <sup>3</sup> /hr]	22	62	220	280
Max Flow Dwell Time [second]	38	41	21	35
@1min Dwell Time Flow Rate [m <sup>3</sup> ]	14	43	77	164.4
@1.5 min Dwell Time Flow Rate [m <sup>3</sup> /hr]	9.6	28.4	51.6	109.6
@2 min Dwell Time Flow Rate [m <sup>3</sup> /hr]	7	21	39	82
Dry Weight [kg]	100	180	262	420
Operational Weight [kgs]	435	970	1650	3265
Body Material	PP	PP	PP	PP
Venturi Pump Qty [pcs]	1	1	1	1
Venturi Pump Model	21-40/54H	21-40/58H G	21-81/33	21-81/33
Nominal Air Suction [Nm <sup>3</sup> /hr]	6.7	10	30	30

PSF-360	PSF-600	PSF-800	PSF-1300	PSF-1500
2100	2820	2900	3805	4185
2810	3350	4000	4775	5435
1500	2000	2350	3000	3400
3630	3705	4800	4825	4825
4.55	11	11	15	22
4	8.4	8.8	11	19.5
3~400/230	3~400/230	3~400/230	3~400/230	3~400/230
225	315	400	500	630
1	1	1	1	1
2300	2185	2700	2723	2593
280	315	400	500	630
1	1	1	1	1
2259	2179	2560	2560	2560
4.5	8.09	14.5	23	29
2806-3156	2922-3372	3095-3305	3665-4065	3665-4065
63	90	90	90	90
360	600	750	1300	1500
45	49	42	64	70
270	485	870	1380	1740
180	323.6	580	920	1160
135	243	435	690	870
530	760	1185	1960	2070
5365	9800	13585	25000	29000
PP	PP	PP	PP	PP
1	1	1	1	1
21-81/34	CMO-N 65-160	CMO-N 65-160	CDI-QL 125-100-200	CDI-QL 125-100-200
40	72	90	130	180

PROTEIN SKIMMER OPTIONAL FEATURES	PSM-14	PSM/F-22	PSM/F-62	PSM/F-220
Electrical Control Panel	optional	optional	optional	optional
Electrical Control Panel Footprint	185x550x770	185x550x770	185x550x770	included in unit
Foam Collector Autowash	Solenoid	Solenoid	Solenoid	Solenoid
Overflow Switch	N/A	optional	optional	optional
ORP Control	optional	optional	optional	optional
Foam Level Automation	N/A	N/A	N/A	optional
Operational Platform	N/A	N/A	N/A	N/A
Passive Ozone destruct	optional	optional	optional	optional
Quick Retractable ORP/PH Probe Fitting	optional	optional	optional	optional
PS Venturi Pump	optional	optional	optional	optional
Ozone Gas Rotameter	optional	optional	optional	optional
Outer Wash Port & Valve for Chemical Dosing	optional	optional	optional	optional
Reuse of off gassed ozone	optional	optional	optional	optional
Sight Glass	optional	optional	optional	optional
Manhole (PP Cover)	N/A	N/A	N/A	N/A
Manhole (Acrylic Cover)	N/A	N/A	N/A	N/A
Ozone Inlet Solenoid Valve SS 316 Body	optional	optional	optional	optional

PSM/F-280	PSM/F-360	PSM/F-600	PSM/F-800	PSM/F-1300	PSM/F-1500
optional	optional	optional	optional	optional	optional
included in unit	included in unit	included in unit	included in unit	included in unit	included in unit
Motorized	Motorized	Motorized	Motorized	Motorized	Motorized
optional	optional	optional	optional	optional	optional
optional	optional	optional	optional	optional	optional
optional	optional	optional	optional	optional	optional
N/A	optional	optional	optional	optional	optional
N/A	N/A	N/A	N/A	N/A	N/A
optional	optional	optional	optional	optional	optional
optional	optional	optional	optional	optional	optional
optional	optional	optional	optional	optional	optional
optional	optional	optional	optional	optional	optional
optional	N/A	N/A	N/A	N/A	N/A
N/A	optional	optional	optional	optional	optional
N/A	optional	optional	optional	optional	optional
optional	optional	optional	optional	optional	optional



PROTEIN SKIMMER OPTIONAL FEATURES	PSM-14	PSM/F-22	PSM/F-62	PSM/F-220
PS Camera	optional	optional	optional	optional
PS PLC Controller	optional	optional	optional	optional



PSM + PSF OPTIONALS

PSM/F-280	PSM/F-360	PSM/F-600	PSM/F-800	PSM/F-1300	PSM/F-1500
optional	optional	optional	optional	optional	optional
optional	optional	optional	optional	optional	optional



PSM + PSF OPTIONALS



# OZONE GENERATORS



Discover the unmatched power and reliability of MAT-KULING's expertly designed and built ozone generators, engineered to excel in the harshest conditions. Our state-of-the-art systems are not only robust and safe but also incredibly user-friendly and easy to maintain, guaranteeing smooth operation in any environment.

MAT-KULING offers a versatile range of reactor sizes, from 5 g/h to 15 kg/h. For large facilities with high ozone production demands, our units, capable of generating up to 15 kg/h of ozone even with a single unit, are designed to exceed expectations. Cus-

tomize your system with optional features like ozone production analyzers, air preparation units, oxygen concentrators, water chillers, and ozone destructors—all seamlessly integrated for optimal performance.

Every MAT-KULING ozone generator comes equipped with advanced PLC control as standard, ensuring precision, reliability, and ease of use. When it comes to high-performance ozone generation, MAT-KULING is your trusted partner.



OZC 1-100 Ozone Production Method	OZC-1	OZC-2	OZC-5
	Corona Discharge		
FootprintWidth [mm]	300	300	800
FootprintDepth [mm]	400	400	600
Max Height[mm]	210	210	400
Device Weight[kg]	15	16	70
Supply Voltage 50/60 Hz[V]	1~230	1~230	1~230
Nominal Energy Consumption[Wh]	100	130	1000
Installed Power[W]	115	147	1100
Total Heat Load[W]	5	7	187
Feeding Type	Vacuum or Pressurized Air / Oxygen	Vacuum or Pressurized Air / Oxygen	Vacuum or Pressurized Air / Oxygen
Feeding/Vacuum, Air Flow Rate[L/min]	10	15	30
Feeding Oxygen Flow Rate[L/min]	1.5	2	6
Oxygen Concentration%	>90	>90	>90
Feeding Oxygen pressurebar	0.8-1.1	0.8-1.1	0.8-1.1
Ozone Output[g/h]	1	2	5
Ozone Flow Rate[L/min]	10	15	30
Ozone Concentration% wt	0.14	0.16	0.2
Ozone Concentration (Oxygen Feed)% wt	0.59	0.68	0.95
Cooling TypeMedia	Air	Air	Air
Cooling Water Flow[m3/h]	N/A	N/A	N/A
Cooling Water ParameterIn/Out C	N/A	N/A	N/A
Ozone Outlet Size[mm] // inc	8	8	8

#### CORONA DISCHARGE OZONE GENERATOR 1-100 GR/HOUR OPTIONAL FEATURES

	OZC-1	OZC-2	OZC-5
Ozone Analyzerg/Nm3	N/A	N/A	N/A
Backflow Prevention DeviceModel	BFP-8	BFP-8	BFP-8
Ozone Generator PLC Controller	Optional	Optional	Optional
Touch Screen Control Board	N/A	N/A	N/A
Dew Point SensorRange	N/A	N/A	N/A
Oxygen Purity SensorRange	0,1-95 %	0,1-95 %	0,1-95 %

OZC-10	OZC-20	OZC-50	OZC-100
Corona Discharge			
1100	1100	1300	1300
700	700	700	700
1500	1500	1600	1800
250	250	250	270
1~230	1~230	1~230	1~230
1400	1600	2000	3100
1500	1700	2100	3200
205	278	597	1438
Ambient Air	Ambient Air	Ambient Air	Ambient Air
N/A	N/A	N/A	N/A
6	6	7.5	15
>90	>90	>90	>90
0.8-1.1	0.8-1.1	0.8-1.1	0.8-1.1
10	20	50	100
6	6	7.5	15
2	4	8	8
N/A	N/A	N/A	N/A
Water	Water	Water	Water
0.75	0.75	1.2	2.5
20	20	20	20
8	8	8	8

#### OZC-10

#### OZC-20

#### OZC-50

#### OZC-100

10-200	10-200	10-200	10-200
BFP-8	BFP-8	BFP-8	BFP-8
Optional	Optional	Optional	Optional
Optional	Optional	Optional	Optional
-50 ... +20 °C TD	-50 ... +20 °C TD	-50 ... +20 °C TD	-50 ... +20 °C TD
0,1-95 %	0,1-95 %	0,1-95 %	0,1-95 %



<b>CORONA DISCHARGE OZONE GENERATOR 1-100 GR/HOUR OPTIONAL FEATURES</b>	<b>OZC-1</b>	<b>OZC-2</b>	<b>OZC-5</b>
Heated Air Dryer Model	HAD-25	HAD-25	HAD-25 (Included as standart product)
Ambient Ozone Detector ppm	0.1	0.1	0.1

<b>OZC-10</b>	<b>OZC-20</b>	<b>OZC-50</b>	<b>OZC-100</b>
N/A	N/A	N/A	N/A
0.1	0.1	0.1	0.1

CORONA DISCHARGE OZONE GENERATOR WITH EXTERNAL OXYGEN SUPPLY	OZO-10	OZO-20	OZO-50	OZO-100	OZO-150
Ozone Production Method	Corona Discharge	Corona Discharge	Corona Discharge	Corona Discharge	Corona Discharge
Footprint Width[mm]	1000	1000	1000	1050	1100
Footprint Depth[mm]	590	590	500	640	700
Height[mm]	1350	1350	1700	1750	1750
Ozone Output[g/h]	10	20	50	100	150
Ozone Concentration [g/m <sup>3</sup> ]	33.35	33.35	66.6	66.6	114.4
Oxygen Concentration%	Min 90%- Max. 99%	Min 90%- Max. 99%	Min 90%- Max. 99%	Min 90%- Max. 99%	Min 90%- Max. 99%
Feeding Oxygen pressure bar	1	1	1	1	1
Feeding Oxygen Dew PointC	< -30	< -30	< -30	< -30	< -30
Feeding Gas Minimum Ni-trogen%	≥1	≥1	≥1	≥1	≥2
Installed Power[W]	220	310	600	1350	1700
Supply Voltage 50/60 Hz[V]	1~220	1~220	1~220	1~220	1~220
Ozone Outlet Size [mm]	8	8	8	8	8
Ozone Flow Rate[L/min]	4.5	10	15	25	25
Total Heat Load [W]	54	63	211	284	426
Air Conditioner Filter+Dryer	1	1	1	1	1
Enclosure Material	Metalic	Metalic	Metalic	Metalic	Metalic
Enclosure RateIP	44	44	44	44	44
Device Weight[kg]	150	170	200	250	320
Ozone Analyzer g/Nm <sup>3</sup>	10-600	10-600	10-600	10-600	10-600
Backflow Prevention Device Model	BFP-8	BFP-8	BFP-8	BFP-8	BFP-8
Ambient Ozone Detector (ppm)	0.1	0.1	0.1	0.1	0.1

OPTIONAL FEATURES	OZO-10	OZO-20	OZO-50	OZO-100	OZO-150
Ozone Analyzer g/Nm <sup>3</sup>	10-600	10-600	10-600	10-600	10-600
Backflow Prevention Device Model	BFP-8	BFP-8	BFP-8	BFP-8	BFP-8
Ambient Ozone Detector ppm	0,1	0,1	0,1	0,1	0,1



CORONA DISCHARGE OZONE GENERATOR & OPTIONAL FEATURES	CORONA DISCHARGE		
	OZO-250	OZO-500	OZO-1000
Ozone Production Method	Corona Discharge		
Footprint Width [mm]	2060	2060	2200
Footprint Depth [mm]	700	780	1100
Max Height [mm]	2000	2200	2100
Device Weight [kg]	370	450	630
Supply Voltage 50/60 Hz [V]	3~400	3~400	3~400
Electrical Connection	3Phase + Neutral + PE	3Phase + Neutral + PE	3Phase + Neutral + PE
Nominal Energy Consumption[kWh]	2.23	4.5	8.9
Installed Power[kW]	2.5	5	10
Nominal Current[A]	6	11	22
Total Heat Loadkcal/h	2500	5000	10000
Min-Max Ozone Variable Ozone Production Range[g/h]	10.0-250.0	10.0-500.0	10.0-1000.0
Feeding Type	Oxygen	Oxygen	Oxygen
Feeding Oxygen Flow Rate[L/min]	35	70	130
Oxygen Concentration%	>90	>90	>90
Feeding Oxygen pressure (nominal) bar	1	1	1
Min-Max Feeding Oxygen Pressure Rangebar	0.5-3	0.5-3	0.5-3
Feeding Oxygen Dew PointC	< -70	< -70	< -70
Feeding Gas Minimum Nitrogen%	≥1	≥1	≥1
Ozone Output[g/h]	250	500	1000
Ozone Flow Rate[L/min]	35	70	130
Ozone Concentration (nominal)% wt	9	9	9
Min-Max Ozone Concentration Working Range%wt	6.0 - 15.0	6.0 - 15.0	6.0 - 15.0
Cooling Type	Water Cooled	Water Cooled	Water Cooled
Cooling Water Flow[m <sup>3</sup> /h]	1	1	3
Cooling Water max pressure[bar]	6	6	6
Cooling Water ParameterIn/Out C	20--22	20--22	20--22
Ozone Generator PLC Controller	Standard	Standard	Standard
Ozone Outlet Size [mm] // inc	1/4"	1/4"	1/2"
Control Panel Type / Comunication	PLC/HMI/TCP IP	PLC/HMI/TCP IP	PLC/HMI/TCP IP

CORONA DISCHARGE			
OZO-1500	OZO-2000	OZO-3000	OZO-4000
Corona Discharge			
2200	2200	2200	3000
1200	1200	1500	1700
2150	2150	2250	2250
800	1000	1300	1700
3~400	3~400	3~400	3~400
3Phase + Neutral + PE	3Phase + Neutral + PE	3Phase + Neutral + PE	3Phase + Neutral + PE
13.4	17.8	26.7	35.6
15	20	30	40
33	44	67	89
15000	20000	30000	40000
10.0-1500.0	10.0-2000.0	10.0-3000.0	400.0-4000.0
Oxygen	Oxygen	Oxygen	Oxygen
200	260	400	520
>90	>90	>90	>90
1	1	1	1
0.5-3	0.5-3	0.5-3	0.5-3
< -70	< -70	< -70	< -70
≥1	≥1	≥1	≥1
1500	2000	3000	4000
200	260	400	520
9	9	9	9
6.0 - 15.0	6.0 - 15.0	6.0 - 15.0	6.0 - 15.0
Water Cooled	Water Cooled	Water Cooled	Water Cooled
5	6	8	9.5
6	6	6	6
20--22	20--22	20--22	20--22
Standard	Standard	Standard	Standard
1/2"	1/2"	3/4"	1"
PLC/HMI/TCP IP	PLC/HMI/TCP IP	PLC/HMI/TCP IP	PLC/HMI/TCP IP

CORONA DISCHARGE OZONE GENERATOR & OPTIONAL FEATURES	OZO-5000	OZO-6500	OZO-8000
	Corona Discharge		
Ozone Production Method	Corona Discharge		
Footprint Width [mm]	3000	3000	3000
Footprint Depth [mm]	2000	2000	2200
Max Height[mm]	2250	2250	2250
Device Weight[kg]	2200	3500	4500
Supply Voltage 50/60 Hz[V]	3~400	3~400	3~400
Nominal Energy Consumption[kWh]	46.5	60.5	74.4
Installed Power[kW]	50	65	80
Total Heat Loadkcal/h	50000	65000	80000
Min-Max Ozone Variable Ozone Production Range [%]	10-100%	10-100%	10-100%
Feeding Type	Oxygen	Oxygen	Oxygen
Feeding Oxygen Flow Rate[L/min]	650	850	1050
Oxygen Concentration%	>90	>90	>90
Feeding Oxygen pressure (nominal) bar	1	1	1
Min-Max Feeding Oxygen Pressure Rangebar	0.5-3	0.5-3	0.5-3
Feeding Oxygen Dew PointC	< -70	< -70	< -70
Feeding Gas Minimum Nitrogen%	≥1	≥1	≥1
Ozone Output[g/h]	5000	6500	8000
Ozone Flow Rate[L/min]	650	850	1050
Ozone Concentration (nominal)% wt	9	9	9
Cooling Type	Water Cooled	Water Cooled	Water Cooled
Cooling Water Flow[m <sup>3</sup> /h]	12	33	42
Cooling Water max pressure[bar]	6	6	6
Cooling Water ParameterIn/Out C	20--22	20--22	20--22
Ozone Generator PLC Controller	Standard	Standard	Standard
Ozone Outlet Size[mm] // inc	1"	1"	1-1/4"
Control Panel Type / Communication	PLC/HMI/TCP IP	PLC/HMI/TCP IP	PLC/HMI/TCP IP

OZO-10000	OZO-15000
Corona Discharge	
4200	4200
2200	2200
2250	2250
5500	7000
3~400	3~400
93	139.5
100	150
100000	150000
10-100%	10-100%
Oxygen	Oxygen
1300	1950
>90	>90
1	1
0.5-3	0.5-3
< -70	< -70
≥1	≥1
10000	15000
1300	1950
9	9
Water Cooled	Water Cooled
55	85
6	6
20--22	20--22
Standard	Standard
1-1/4"	1-1/2"
PLC/HMI/TCP IP	PLC/HMI/TCP IP

AIR PREPARATION UNITS 250-35000 LP-MUNITS	APU-250	APU-500	APU-1000	APU-2000
Footprint Width [mm]	1700	1800	2200	2250
Depth [mm]	750	860	1000	2000
Max Height[mm]	1500	2000	2000	1700
Device Weight[kg]	370			
Supply Voltage 50/60 Hz[V]	3~400	3~400	3~400	3~400
Installed Power[kW]	3.6	6.5	12	19.5
Air Flowrate @5 bar[L/min]	250	500	1000	2000
Pressure Dew Point°C	4	4	4	4
Max. Output Pressurebar	10	10	10	10
Air Receiver Capacity[L]	200	300	500	1000
Refrigeration dryer	Included	Included	Included	Included
Sound Level @1 mtdBA	65	65	65	65
Touch Screen Control Board	Optional	Optional	Optional	Optional
Dew Point SensorRange	-50 ... +20 °C TD	-50 ... +20 °C TD	-50 ... +20 °C TD	-50 ... +20 °C TD

APU-3000	APU-5000	APU-10000	APU-18000	APU-35000
2300	2250	2200	1700	3600
2000	2600	5000	6500	4000
1900	2550	1900	2550	3600
3~400	3~400	3~400	3~400	3~400
23	32	80	138	255
3000	5000	10000	18000	35000
4	4	4	4	4
10	10	10	10	10
1000	2000	3000	4000	4000
Included	Included	Included	Included	Included
65	65	65	65	65
Optional	Optional	Optional	Optional	Optional
-50 ... +20 °C TD	-50 ... +20 °C TD	-50 ... +20 °C TD	-50 ... +20 °C TD	-50 ... +20 °C TD



OXYGEN CONCENTRATOR UNITS 6-2500 LPM	OX-12	OX-20	OX-40	OX-80	OX-160
Footprint Width [mm]	400	460	450	650	850
Footprint Depth [mm]	185	190	400	450	550
Max Height [mm]	650	650	1250	1900	2000
Supply Voltage 50/60 Hz [V]	24	24	1~230	1~230	1~230
Installed Power (W)	300	300	500	500	500
Oxygen Flowrate @1 bar ([L/min])	12	20	40	80	160
Optional Features Touch Screen Control Board	Optional	Optional	Optional	Optional	Optional
Optional Features Oxygen Purity Sensor Range	%0-99	%0-99	%0-99	%0-99	%0-99
Optional Features Dew Point Sensor Range	-50 ... +20 °C TD	-50 ... +20 °C TD	-50 ... +20 °C TD	-50 ... +20 °C TD	-50 ... +20 °C TD

OX-250	OX-400	OX-750	OX-1500	OX-2500	OX-2500
1000	1200	1700	2005	2450	2450
750	750	1000	1115	1600	1600
2250	2300	2500	2900	3500	3500
1~230	1~230	1~230	1~230	1~230	1~230
500	500	500	500	500	500
250	400	750	1500	2500	2500
Optional	Optional	Optional	Optional	Optional	Optional
%0-99	%0-99	%0-99	%0-99	%0-99	%0-99
-50 ... +20 °C TD	-50 ... +20 °C TD	-50 ... +20 °C TD	-50 ... +20 °C TD	-50 ... +20 °C TD	-50 ... +20 °C TD

# BACKFLOW PREVENTION DEVICE

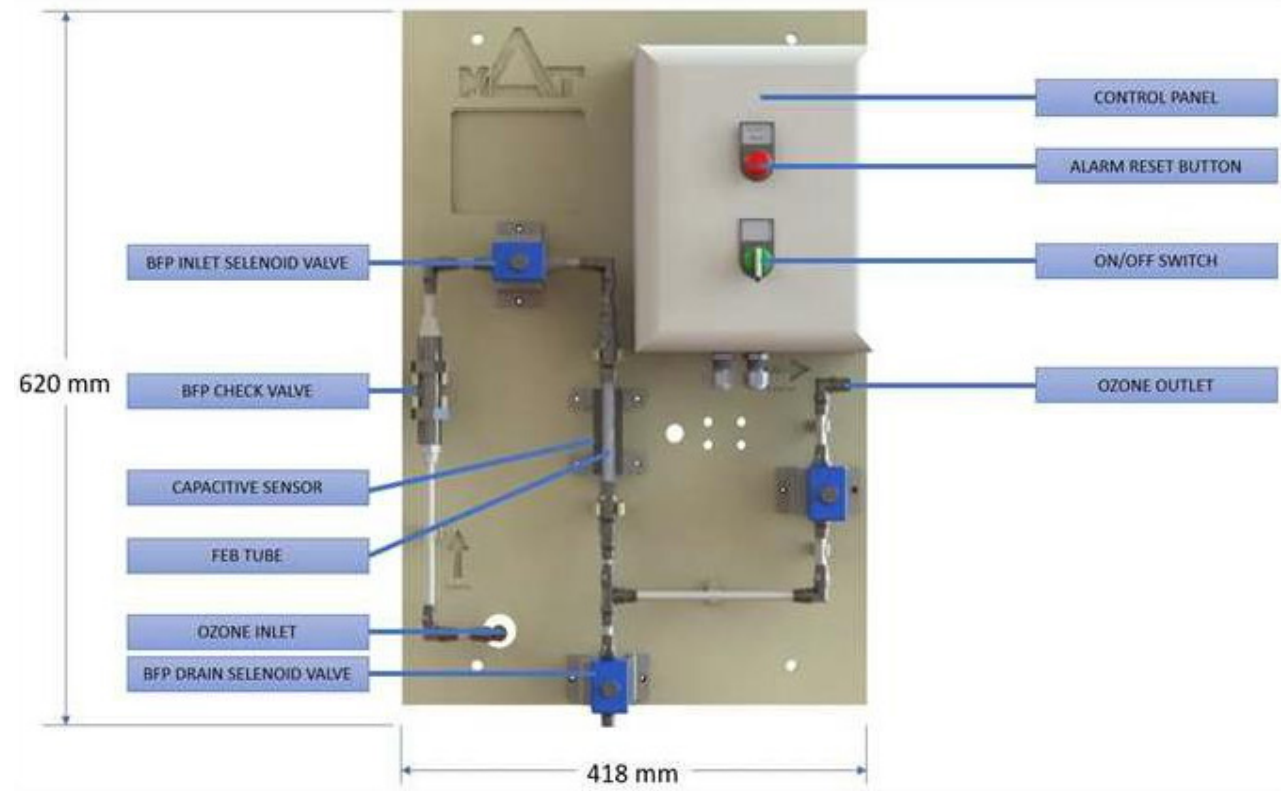

BACKFLOW PREVENTION DEVICE:	BFP-8	BFP-15	BFP-22	BFP-35	BFP-42	BFP-50
Footprint Width (mm)	130	190	200	200	250	500
Footprint Depth (mm)	150	270	280	310	380	400
Max. Height (mm)	300	400	500	500	600	1000
Total Electric Power (W)	25	20	20	25	50	80
Power Supply	230V 50Hz	230V 50Hz	230V 50Hz	230V 50Hz	230V 50Hz	230V 50Hz
Dry Weight (Kg)	3	7	10	15	20	20
Protection Rate	66	66	66	66	66	66
Pipe Material	Teflon	316 Stainless Steel	316 Stainless Steel	316 Stainless Steel	316 Stainless Steel	316 Stainless Steel
Piping Pressure Rate	PN10	PN10	PN10	PN10	PN10	PN10
BFP Vessel Material	Teflon	Teflon	Teflon	Teflon	Teflon	Boro-silicate Glass
Connection Dimension to BFP	8 mm	1/4"	1/2"	1"	1 1/2"	2"
Solenoid Valves Material	316 Stainless Steel	316 Stainless Steel	316 Stainless Steel	316 Stainless Steel	316 Stainless Steel	316 Stainless Steel

BFP SPECIFICATIONS



## DRUM FILTERS



MAT Kuling Drum Filters are mechanical units that provide an efficient, robust, and reliable solution for solid matter separation.

Our automatic self-cleaning micro-screen filters are capable of handling a wide range of flow rates, from 5 m<sup>3</sup>/h to 8,000 m<sup>3</sup>/h, and support backwashing using micron ratings ranging from 10 µm to 1,000 µm.

They are designed for high-performance filtration and extended reliability, making them ideal for mission-critical water treatment applications, especially in

land-based aquaculture.

MK Drum Filters are available in Tank Type, Half Tank Type, and Channel Type configurations, with options for non-metallic engineered plastic or steel materials. Filter panels are modular and protected by a patent-pending support structure.

The filters are energy-efficient, featuring intermittent and continuous backwash modes to minimize water consumption. The Smart Wash Logic Control enables operational mode selection, rotational speed adjustment, and autonomous optimization for effective cleaning.

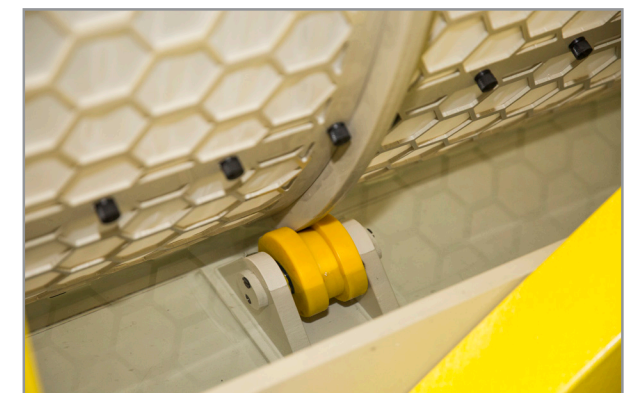
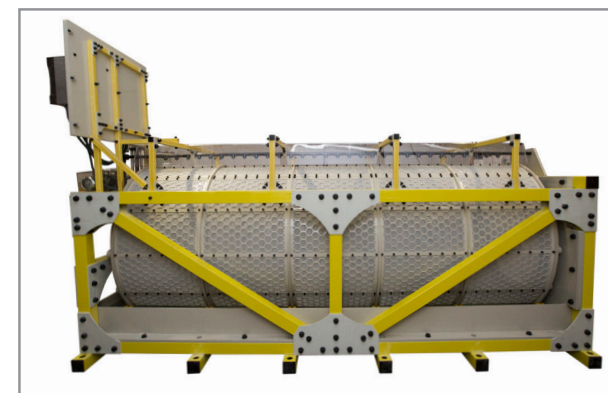
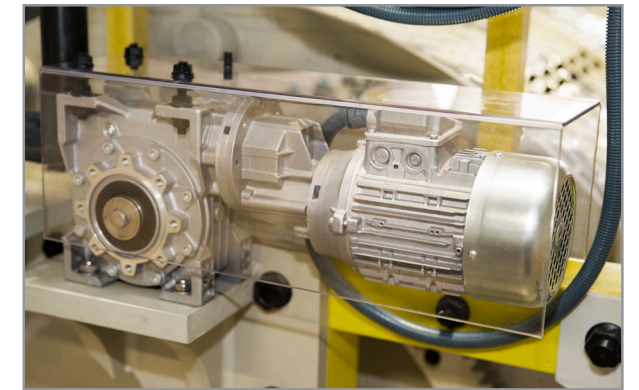
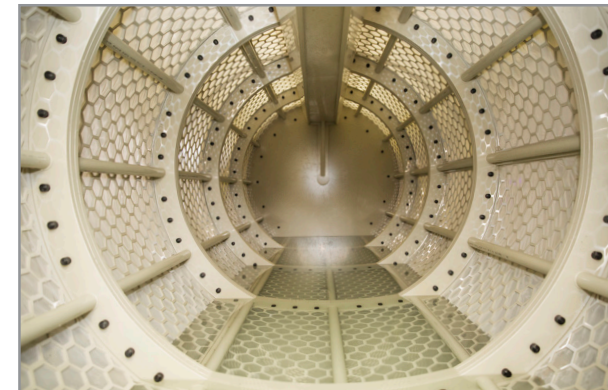
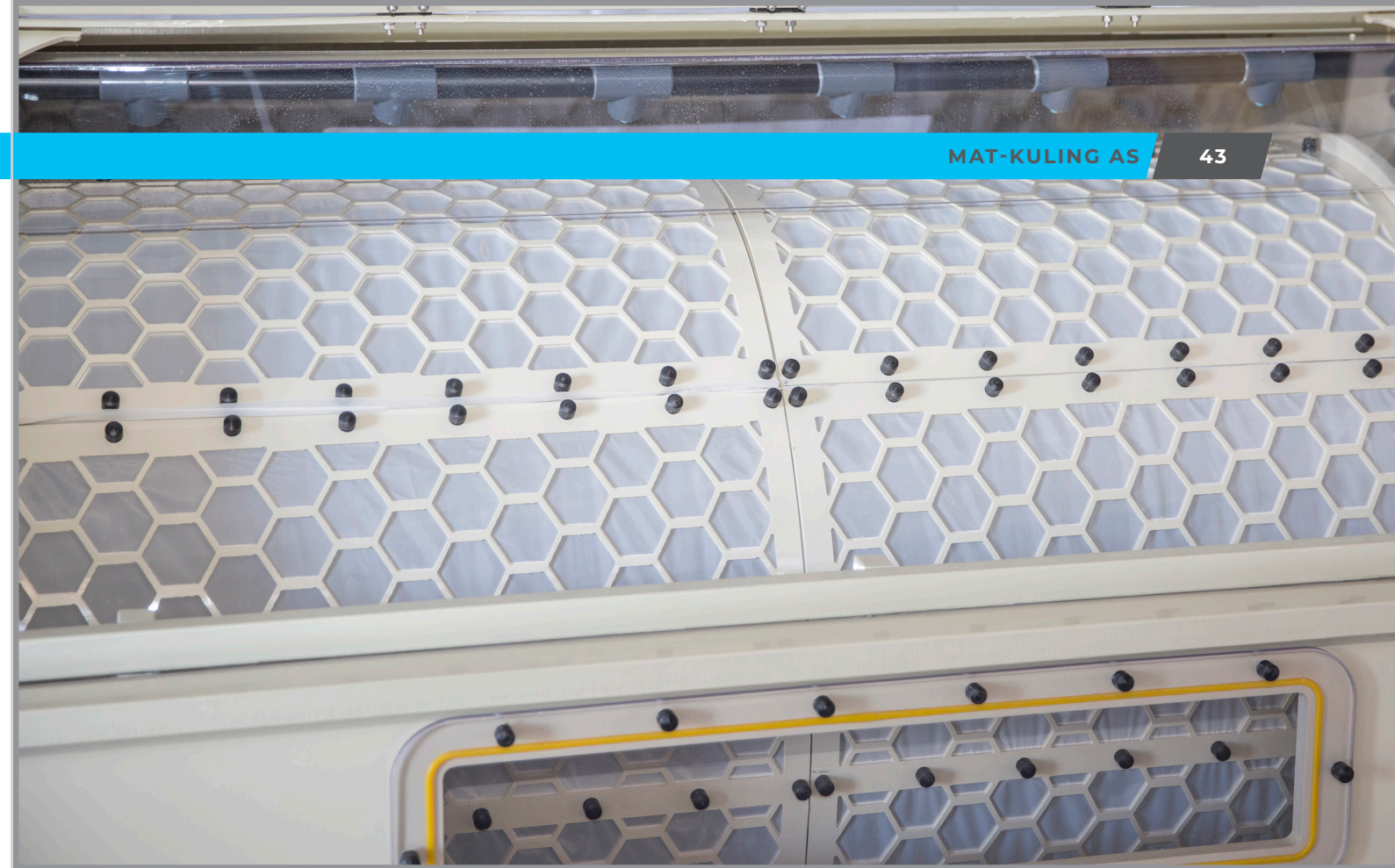
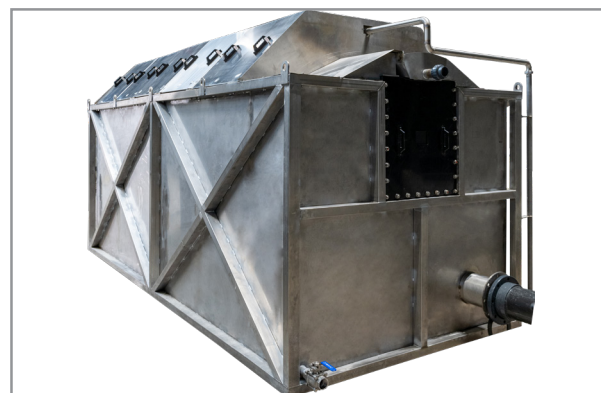



**DRUM FILTERS  
OPTIONAL FEATURES**

**ALL MODELS**

Drum Auto wash as per Water Level  
Fixed Drum Wash Rotation Speed

OPTIONAL

Drum Auto wash as per Water Level Error/Status/  
Alarm Function via Digital Screen Drum Filter Rotation  
Modes PROFINET/MODBUS Connection Including  
Smart Relay/Power Supply/Driver Units

OPTIONAL

Error/Status/Alarm Function via Touch Screen Drum  
Filter Rotation Modes PROFINET/MODBUS Con-  
nection Including PLC/HMI/Power Supply/Driver Units

OPTIONAL

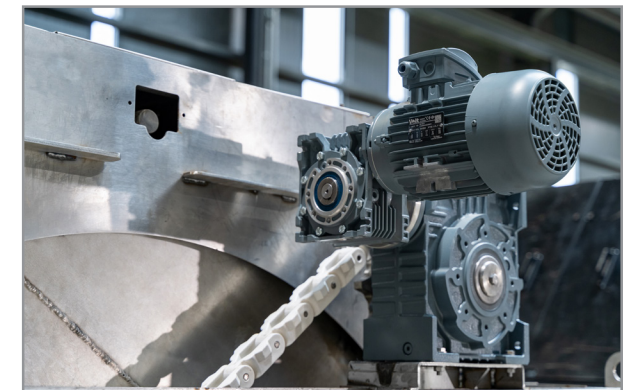
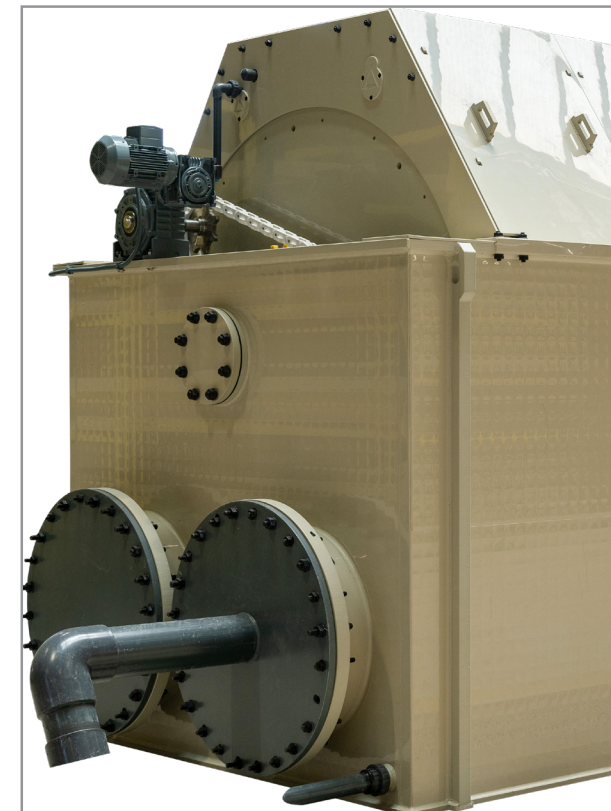



DRUM FILTER MODEL	DRF-400-1	DRF-800-1	DRF-800-2	DRF-800-3
Drum diameter[mm]	400	800	800	800
Drum length[mm]	385	385	770	1155
Screen Panel Type-	SP-2	SP-2	SP-2	SP-2
Per Panel Aream2	0.46	0.46	0.46	0.46
Total Panel Aream2	0.46	0.92	1.84	2.76
Total Screen Panel Quantitypcs	1	2	4	6
Per Segment Panel Quantitypcs	1	2	2	2
Screen Panel Dimensions[mm]	385 x 1200	385 x 1200	385 x 1200	385 x 1200
Available Types: T(Tank), HT(Half Tank), C(Channel)	T/HT/C	T/HT/C	T/HT/C	T/HT/C
Available Tank/Housing Wall Material-	Polymer	Polymer	Polymer	Polymer
Drum Structure Material-	Polymer	Polymer	Polymer	Polymer
Frame Material-	Polymer	Polymer	Polymer	Polymer
Lid/Cover Material-	Polymer	Polymer	Polymer	Polymer
Seal/Gasket Material-	EPDM	EPDM	EPDM	EPDM
Bacwash Water Flow[m <sup>3</sup> /hr]	1.08	1.08	2.16	3.24
Required Backwash PressureBar	45481	45481	45481	45481
Mesh Size Rangemicron	10-500	10-500	10-500	10-500
Available Screen Panel Mesh Material-	PET Monofila- ment	PET Mono- filament / 304/316/Du- plex	PET Mono- filament /304/316/Du- plex	PET Mono- filament /304/316/Du- plex

DRF-1200-3	DRF-1200-4	DRF-1600-4	DRF-1600-6	DRF-1600-8	DRF-2000-7
1200	1200	1600	1600	1600	2000
1155	1540	1540	2310	3080	2695
SP-2	SP-2	SP-2	SP-2	SP-2	SP-2
0.46	0.46	0.46	0.46	0.46	0.46
4.14	5.52	7.36	11.04	14.72	16.1
9	12	16	24	32	35
3	3	4	4	4	5
385 x 1200	385 x 1200	385 x 1200	385 x 1200	385 x 1200	385 x 1200
T/HT/C	T/HT/C	T/HT/C	T/HT/C	T/HT/C	T/HT/C
Polymer	Polymer	Poly- mer/304/316/ Duplex	Poly- mer/304/316/ Duplex	Poly- mer/304/316/ Duplex	Poly- mer/304/316/ Duplex
Polymer	Polymer	Poly- mer/304/316/ Duplex	Poly- mer/304/316/ Duplex	Poly- mer/304/316/ Duplex	Poly- mer/304/316/ Duplex
Polymer	Polymer	Poly- mer/304/316/ Duplex	Poly- mer/304/316/ Duplex	Poly- mer/304/316/ Duplex	Poly- mer/304/316/ Duplex
Polymer	Polymer	Polymer	Polymer	Polymer	Polymer
EPDM	EPDM	EPDM	EPDM	EPDM	EPDM
3.24	4.32	4.32	6.48	8.64	7.56
45481	45481	45481	45481	45481	45481
10-500	10-500	10-500	10-500	10-500	10-500
PET Mono- filament /304/316/Du- plex	PET Mono- filament /304/316/Du- plex	PET Mono- filament /304/316/Du- plex	PET Mono- filament /304/316/Du- plex	PET Mono- filament /304/316/Du- plex	PET Mono- filament /304/316/Du- plex



DRUM FILTER MODEL	DRF-400-1	DRF-800-1	DRF-800-2	DRF-800-3
Available Screen Panel Grid Support Material-	Poly-mer/304/316/ Duplex	Poly-mer/304/316/ Duplex	Poly-mer/304/316/ Duplex	Poly-mer/304/316/ Duplex
Drive Type-	Direct Drive Gears	Direct Drive Gears	Direct Drive Gears	Direct Drive Gears
Drive/Chain Material-	Polymer	Polymer	Polymer	Polymer
Support Wheel Material-	Polymer	Polymer	Polymer	Polymer
Electrical Panel Supply (4-Wire)Ph~V @ 50 Hz	3Ph~400V	3Ph~400V	3Ph~400V	3Ph~400V
Tank Type Max Hydraulic Capacity	64.3	128.6	257.3	385.9
Half Type Max Hydraulic Capacity	80.4	160.8	321.6	482.4
Channel Type Max Hydraulic Capacity	96.5	192.9	386	578.9

DRUM FILTER MODEL	DRF-2000-8	DRF-2000-9	DRF-2000-10	DRF-2000-12
Drum diameter[mm]	2000	2000	2000	2000
Drum length[mm]	3080	3465	3850	4620
Screen Panel Type-	SP-2	SP-2	SP-2	SP-2
Per Panel Area <sup>m2</sup>	0.46	0.46	0.46	0.46
Total Panel Area <sup>m2</sup>	18.4	20.7	23	27.6
Total Screen Panel Quantity <sup>pcs</sup>	40	45	50	60
Per Segment Panel Quantity <sup>pcs</sup>	5	5	5	5
Screen Panel Dimensions[mm]	385 x 1200	385 x 1200	385 x 1200	385 x 1200
Available Types: T(Tank), HT(Half Tank), C(Channel)	T/HT/C	T/HT/C	T/HT/C	T/HT/C
Available Tank/Housing Wall Material-	Poly-mer/304/316/ Duplex	Poly-mer/304/316/ Duplex	Poly-mer/304/316/ Duplex	Poly-mer/304/316/ Duplex

DRF-1200-3	DRF-1200-4	DRF-1600-4	DRF-1600-6	DRF-1600-8	DRF-2000-7
Poly-mer/304/316/ Duplex	Poly-mer/304/316/ Duplex	Poly-mer/304/316/ Duplex	Poly-mer/304/316/ Duplex	Poly-mer/304/316/ Duplex	Poly-mer/304/316/ Duplex
Direct Drive Gears	Direct Drive Gears	Chain	Chain	Chain	Chain
Polymer	Polymer	Polymers (with 316, Du-plex, Ti Pins)	Polymers (with 316, Du-plex, Ti Pins)	Polymers (with 316, Du-plex, Ti Pins)	Polymers (with 316, Du-plex, Ti Pins)
Polymer	Polymer	Polymer	Polymer	Polymer	Polymer
3Ph~400V	3Ph~400V	3Ph~400V	3Ph~400V	3Ph~400V	3Ph~400V
578.9	771.8	1029.1	1543.7	2058.3	2251.2
723.6	964.8	1286.4	1929.6	2572.9	2814
868.4	1157.7	1543.7	2315.6	3087.5	3376.8

DRF-2000-16	DRF-2000-18
2000	2000
6160	6930
SP-2	SP-2
0.46	0.46
36.8	41.4
80	90
5	5
385 x 1200	385 x 1200
C	C
304/316/Du-plex	304/316/Du-plex

DRUM FILTER MODEL	DRF-2000-8	DRF-2000-9	DRF-2000-10	DRF-2000-12
Drum Structure Material-	Polymer/304/316/Duplex	Polymer/304/316/Duplex	Polymer/304/316/Duplex	Polymer/304/316/Duplex
Frame Material-	Polymer/304/316/Duplex	Polymer/304/316/Duplex	Polymer/304/316/Duplex	Polymer/304/316/Duplex
Lid/Cover Material-	Polymer	Polymer	Polymer	Polymer
Seal/Gasket Material-	EPDM	EPDM	EPDM	EPDM
Bacwash Water Flow[m <sup>3</sup> /hr]	8.64	9.72	10.8	12.96
Required Backwash PressureBar	45481	45481	45481	45481
Mesh Size Rangemicron	10-500	10-500	10-500	10-500
Available Screen Panel Mesh Material-	PET Mono-filament /304/316/Duplex	PET Mono-filament /304/316/Duplex	PET Mono-filament /304/316/Duplex	PET Mono-filament /304/316/Duplex
Available Screen Panel Grid Support Material-	Polymer/304/316/Duplex	Polymer/304/316/Duplex	Polymer/304/316/Duplex	Polymer/304/316/Duplex
Drive Type-	Chain	Chain	Chain	Chain
Drive/Chain Material-	Polymers (with 316, Duplex, Ti Pins)	Polymers (with 316, Duplex, Ti Pins)	Polymers (with 316, Duplex, Ti Pins)	Polymers (with 316, Duplex, Ti Pins)
Suppor Wheel Material-	Polymer	Polymer	Polymer	Polymer
Electrical Panel Supply (4-Wire)Ph~V @ 50 Hz	3Ph~400V	3Ph~400V	3Ph~400V	3Ph~400V
Tank Type Max Hydraulic Capacity	2572.8	2894.4	3216	3859.2
Half Type Max Hydraulic Capacity	3216	3618	4020	4824
Channel Type Max Hydraulic Capacity	3859.2	4341.6	4824	5788.8

DRF-2000-16	DRF-2000-18
304/316/Duplex	304/316/Duplex
304/316/Duplex	304/316/Duplex
Polymer	Polymer
EPDM	EPDM
17.28	19.44
45481	45481
10-500	10-500
PET Mono-filament /304/316/Duplex	PET Mono-filament /304/316/Duplex
Polymer/304/316/Duplex	Polymer/304/316/Duplex
Chain	Chain
Polymers (with 316, Duplex, Ti Pins)	Polymers (with 316, Duplex, Ti Pins)
Polymer	Polymer
3Ph~400V	3Ph~400V
5145.6	5788.8
6432	7236
7718.4	8683.2



DRUM FILTER FLOW CAPACITIES [M<sup>3</sup>/H]

MESH SIZE (μ)	(Design TSS - mg/l)	DRF-400-1	DRF-800-1	DRF-800-2	DRF-800-3	DRF-1200-3	DRF-1200-4
20	10	14	28	56	84	127	169
20	15	12	25	51	77	115	154
20	30	11	23	46	70	105	140
20	100	7	15	30	45	68	91
25	10	23	47	94	141	212	282
25	15	21	42	85	128	192	257
25	30	19	39	77	116	175	233
25	100	12	25	50	76	113	151
30	10	33	67	134	202	303	404
30	15	30	61	122	183	275	367
30	30	27	55	111	166	250	333
30	100	18	36	72	108	162	217
40	10	48	96	192	288	432	577
40	15	43	87	174	262	393	524
40	30	39	79	159	238	357	476
40	100	25	51	103	155	232	310
50	10	60	120	240	360	541	721
50	15	54	109	218	327	491	655
50	30	49	99	198	298	447	596

DRF-1600-4	DRF-1600-6	DRF-1600-8	DRF-2000-7	DRF-2000-8	DRF-2000-9	DRF-2000-10	DRF-2000-12	DRF-2000-16	DRF-2000-18
226	339	452	494	565	636	706	848	1131	1272
205	308	411	449	514	578	642	771	1028	1156
187	280	373	409	467	525	584	701	934	1051
121	182	243	265	303	341	379	455	607	683
377	565	754	824	942	1060	1178	1413	1885	2120
342	514	685	749	856	964	1071	1285	1713	1928
311	467	623	681	779	876	973	1168	1558	1752
202	303	405	443	506	569	632	759	1012	1139
538	807	1077	1178	1346	1514	1683	2019	2693	3029
489	734	979	1071	1224	1377	1530	1836	2448	2754
445	667	890	973	1112	1251	1391	1669	2225	2503
289	434	578	632	723	813	904	1085	1446	1627
769	1154	1538	1683	1923	2164	2404	2885	3847	4328
699	1049	1399	1530	1748	1967	2185	2623	3497	3934
635	953	1271	1391	1589	1788	1987	2384	3179	3576
413	620	826	904	1033	1162	1291	1550	2066	2325
961	1442	1923	2104	2404	2705	3005	3606	4809	5410
874	1311	1748	1912	2185	2459	2732	3278	4371	4918
794	1192	1589	1738	1987	2235	2484	2980	3974	4471

MESH SIZE (μ)	(Design TSS - mg/l)	DRF-400-1	DRF-800-1	DRF-800-2	DRF-800-3	DRF-1200-3	DRF-1200-4
50	100	32	64	129	193	290	387
60	10	64	128	257	385	578	771
60	15	58	116	233	350	526	701
60	30	53	106	212	318	478	637
60	100	34	69	138	207	311	414
100	10	70	141	283	424	636	849
100	15	64	128	257	385	578	771
100	30	58	116	233	350	526	701
100	100	38	76	152	228	342	456

DRF-1600-4	DRF-1600-6	DRF-1600-8	DRF-2000-7	DRF-2000-8	DRF-2000-9	DRF-2000-10	DRF-2000-12	DRF-2000-16	DRF-2000-18
516	775	1033	1130	1291	1453	1614	1937	2583	2906
1029	1543	2058	2251	2572	2894	3216	3859	5145	5788
935	1403	1871	2046	2338	2631	2923	3508	4677	5262
850	1275	1701	1860	2126	2392	2657	3189	4252	4784
552	829	1105	1209	1382	1554	1727	2073	2764	3109
1132	1698	2264	2476	2830	3183	3537	4245	5660	6367
1029	1543	2058	2251	2572	2894	3216	3859	5145	5788
935	1403	1871	2046	2338	2631	2923	3508	4677	5262
608	912	1216	1330	1520	1710	1900	2280	3040	3420



## UV DISINFECTION UNITS



The comparative advantage of the UV disinfection system over various chemical disinfection methods is the unaffected physical and chemical composition of water after the UV radiation activity. The UV is effective against any type of microorganism such as algae, bacteria, virus, fungi, yeasts to provide biosecurity.

MAT-KULING produces closed UV vessels/ reactors with Food Grade Polypropylene material up to 1000m<sup>3</sup>/h.

The UV C units are equipped with temperature sensors as standard and UV intensity

sensor and PLC controller optionally.

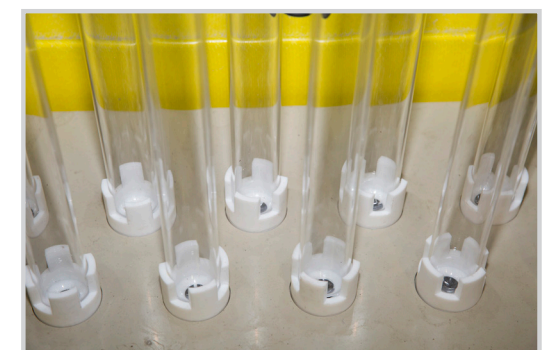



UV MODEL	UVC-1	UVC-5	UVC-10	UVC-20	UVC-50
Product Description	UV DIS-INFECTION UNIT-PP BODY				
Nominal Flow Rate [m <sup>3</sup> /h]	1	5	10	20	50
Max Flow Rate [m <sup>3</sup> /h]	2	8	12	30	55
UV dose-nominal flow [mJ/cm <sup>2</sup> ]	40	46.3	42.3	43.9	44.4
Lamp UV 254 nm efficiency [%]	38	38	38	38	38
Design Water UVT Ratio [%]	98	98	98	98	98
Quartz Sleeve Transmittance Value [%]	93	93	93	93	93
Inlet / Outlet Connection Type	Pipe Fitting Connection				Flange Adaptor with Gasket (RF)
Connection Orientation Standard	U	U	U	U	U
Connection Orientation Options	L/Z	L/Z	L/Z	L/Z	L/Z
Flange/ Pipe Connection Sizes	1" BSP	1 1/2" BSP	3" BSP	3" BSP	DN100
Piping Norm Adopte	ISO1452-2 PN10	ISO1452-2 PN10	ISO1452-2 PN10	ISO1452-2 PN10	ISO1452-2 PN10
Flange Pattern Norm	N/A	N/A	N/A	N/A	ISO1452-3 PN10
Drain Connection Type	Threaded	Threaded	Threaded	Threaded	Threaded
Drain Size [in]	½	½	½	½	½
UV Reactor Body Material	PP	PP	PP	PP	PP
UV Reactor Diameter (Ø) [mm]	63	75	160	160	140
UV Reactor Length [mm]	650	745	765	765	1785
UV Reactor Width [mm]	135	160	190	190	255
UV Reactor Height [mm]	300	300	350	350	425
Operation Temperature Range C	2 C-45 C	2 C-45 C	2 C-45 C	2 C-45 C	2 C-45 C

UVC-100	UVC-250	UVC-350	UVC-500	UVC-700	UVC-1000
UV DIS-INFECTION UNIT-PP BODY					
100	250	350	500	700	1000
115	300	370	500	700	1000
43.5	43	42.8	45.6	45.6	31.4
38	38	38	38	38	38
98	98	98	98	98	98
93	93	93	93	93	93
U	U	U	U	U	U
L/Z	L/Z	L/Z	L/Z	L/Z	L/Z
DN150	DN200	DN300	DN400	DN400	DN400
ISO1452-2 PN10	ISO1452-2 PN10	ISO1452-2 PN10	ISO1452-2 PN10	ISO1452-2 PN10	ISO1452-2 PN10
ISO1452-3 PN10	ISO1452-3 PN10	ISO1452-3 PN10	ISO1452-3 PN10	ISO1452-3 PN10	ISO1452-3 PN10
Threaded	Threaded	Threaded	Threaded	Threaded	Threaded
½	½	½	½	½	½
PP	PP	PP	PP	PP	PP
200	315	355	500	500	500
1785	1785	1760	1795	1785	1785
300	345	500	600	600	600
510	610	660	780	795	785
2 C-45 C	2 C-45 C	2 C-45 C	2 C-45 C	2 C-45 C	2 C-45 C

UV MODEL	UVC-1	UVC-5	UVC-10	UVC-20	UVC-50
Max Operating Pressure [bar]	2	5	5	5	5
Test pressure [bar]	3	7.5	7.5	7.5	7.5
UV Reactor Temperature Alarm	Standard	Standard	Standard	Standard	Standard
Number Of UV Lamps [pcs]	1	1	2	3	1
Lamp Category	Low Pressure Amalgam Lamp	Low Pressure Amalgam Lamp	Low Pressure Amalgam Lamp	Low Pressure Amalgam Lamp	Low Pressure Amalgam Lamp
Lamp Lifespan [h]	17000	17000	17000	17000	17000
Power Per Lamp [W]	48	87	87	87	400
UV Lamp Standard Cable Length [m]	6	6	6	6	6
Electrical Panel Protection Class	IP66	IP55	IP55	IP55	IP55
UV Body Operational Weight [kg]	4	6,6	9,6	11,9	34,9
UV Body Dry Weight (UV Chamber) [kg]	1,8	2,3	3,2	5,2	8,1
Control Board Width [mm]	400	400	500	500	500
Control Board Depth [mm]	210	210	210	210	210
Control Board Length [mm]	300	300	400	400	400
Control Board Dry Weight [kg]	4	6	6,8	7,5	6,8
Total Current [A]	0.3A	0.5A	1A	1.5A	2.5A
Total Installed Power [kW]	0.04	0.1	0.2	0.3	0.4
Supply Voltage 50/60Hz* [V]	1~230V AC	1~230V AC	1~230V AC	1~230V AC	1~230V AC

UVC-100	UVC-250	UVC-350	UVC-500	UVC-700	UVC-1000
5	5	5	5	5	5
7.5	7.5	7.5	7.5	7.5	7.5
Standard	Standard	Standard	Standard	Standard	Standard
2	4	6	8	10	12
Low Pressure Amalgam Lamp	Low Pressure Amalgam Lamp	Low Pressure Amalgam Lamp	Low Pressure Amalgam Lamp	Low Pressure Amalgam Lamp	Low Pressure Amalgam Lamp
17000	17000	17000	17000	17000	17000
400	400	400	400	400	400
6	6	6	6	6	6
IP55	IP55	IP55	IP55	IP55	IP55
64,9	150,4	180,7	433,8	433,8	438,3
14,9	25,7	39,7	120	120	122
600	700	800	800	1000	1000
210	300	400	400	400	400
400	500	450	450	600	600
13,2	18	65	75	85	90
5A	8.5A	7A	8.5A	10A	16A
1.0	1.2	2.4	3.2	4.0	4.8
1~230V AC	1~230V AC	3~400V AC	3~400V AC	3~400V AC	3~400V AC

UV MODEL OPTIONAL FEATURES	UVC-1	UVC-5	UVC-10	UVC-20	UVC-50
PLC Control Board	Optional	Optional	Optional	Optional	Optional
Optional Cable Length Max. [m]	6	6	6	6	6
Digital Flow Meter	Optional	Optional	Optional	Optional	Optional
Body Support Foot	Optional	Optional	Optional	Optional	Optional
Control Board Width (with PLC) [mm]	600	600	600	700	600
Control Board Depth (with PLC) [mm]	210	210	210	300	210
Control Board Length (with PLC) [mm]	400	400	400	500	400
Control Board Dry Weight (with PLC) [kg]	4.3	6.3	7.1	7.8	7.1
UV Irradiance Sensor	Optional	Optional	Optional	Optional	Optional

UVC-100	UVC-250	UVC-350	UVC-500	UVC-700	UVC-1000
Optional	Optional	Optional	Optional	Optional	Optional
6	6	6	6	6	6
Optional	Optional	Optional	Optional	Optional	Optional
Optional	Optional	Optional	Optional	Optional	Optional
700	700	800	800	1000	1000
300	300	400	400	400	400
500	500	450	450	600	600
13.5	18	65	75	85	90
Optional	Optional	Optional	Optional	Optional	Optional



## MBBRs

### MOVING BED BIOFILTER REACTORS



MBBRs are biological filters, fabricated to provide nitrification and degradation of Total Ammonia Nitrogen (TAN) that is highly toxic. MBBR bio towers are made of PP, resistant to osmosis and ozone gas.

The Moving Bed Biofilter Reactor retains the organically loaded water by creating a vortex, to evenly move the bio media into the oxygen-rich, aerated contact chamber.

This retention allows the microorganisms to biologically absorb the nutrients off the water at a higher level than a traditional fixed biological filter. Due to the moving

structure and high specific surface area of MBBR media that play host for nitrification bacteria, MBBR units also have very low footprints compared to fixed type biological filters.

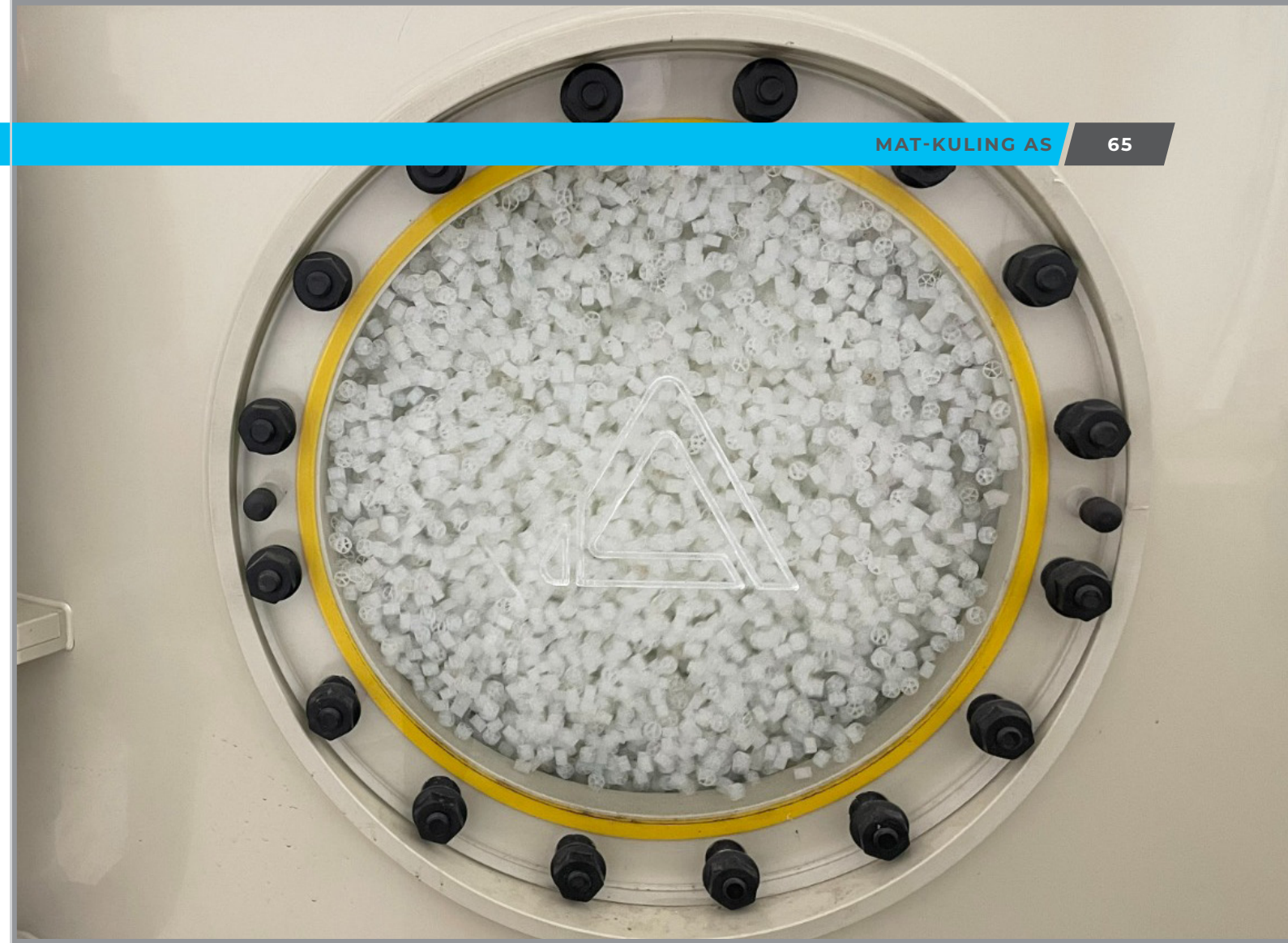

MOVING BED BIOFILM REACTOR (MBB)	MAT MBB-22	MAT MBB-62	MAT MBB-220	MAT MBB-280
Diameter [mm]	500	750	1000	1250
Footprint (WxL) [mm]	950x850	1160x1480	1415x1679	1734x2248
Height [mm]	1643	1865	2095	2353
Installed Power [kW]	0.55	0.75	1.1	2
Basic Unit Total Electric Consumption 50 hZ [kWh]	0.55	0.75	1.1	1.5
Supply Voltage 50hZ/60hZ [V]	3~400/230	3~400/230	3~400/230	3~400/230
Water Inlet Level [mm]	1252	1518	1585	1845
Inlet Size [mm]	90	140	225	250
Water Outlet Level [mm]	1240	1370	1430	1545
Outlet Size [mm]	90	140	225	250
Max water Flow [m <sup>3</sup> /h]	22	62	220	280
Max Flow Retention [second]	45	43	26	32
1 Min Retantion time flow rate [m <sup>3</sup> /h]	16.8	44.4	92	150
2 Min Retantion time flow rate [m <sup>3</sup> /h]	8.4	22.2	46	75

MAT MBB-360	MAT MBB-600	MAT MBB-800	MAT MBB-1300	MAT MBB-1500
1500	2000	2350	3000	3400
1786x2673	2360x3140	3170x3377	3500x3750	3900x4600
3070	3000	4164	4164	4164
3	4	5.5	9.2	11
2.2	3	5.5	9.2	11
3~400/230	3~400/230	3~400/230	3~400/230	3~400/230
2259	2179	3350	3350	3350
280	315	400	500	630
1959	1879	3000	3000	3000
280	315	400	500	630
360	600	819	1300	1500
49	52	71	64	72
294	528	N/A	N/A	N/A
147	264	489	700	900



MOVING BED BIOFILM REACTOR (MBB)	MAT MBB-22	MAT MBB-62	MAT MBB-220	MAT MBB-280
4 Min Retention time flow rate [m <sup>3</sup> /h]	4.2	11.1	23	37.5
Max Air Flow Rate 50hZ [m <sup>3</sup> /h]	20	18	35	54
Blower Model 50hZ	15DH MD	R20 MD	R30 MD	R40 MD
Blower Driver Model	EP66-0007 T3	EP66-0007 T3	EP66-0015 T3	EP66-0022 T3
Reactor Volume [m <sup>3</sup> ]	0.28	0.74	1.54	2.5
Max BM-800 media [m <sup>3</sup> ]	0.18	0.49	1.02	1.72
Max BM-1000 media [m <sup>3</sup> ]	0.17	0.44	0.92	1.47
Dry Weight (wo/media) [kg]	120	130	200	280
Operational Weight [kg]	280	740	1540	2700
Body Material	PP food grade	PP food grade	PP food grade	PP food grade

### MOVING BED BIOFILM REACTOR (MBB) OPTIONAL FEATURES

#### MBB-22 - MBB-1300

Biomedica BM-800	OPTIONAL
Biomedica BM-1000	OPTIONAL
Quick Retractable ORP/PH Probe Fitting	OPTIONAL
IP65 polycarbonate panel, Function/Fault Indicators, Manual Switches, Emergency stop, with visual and audible alarm.	OPTIONAL
Control board modification, PLC unit addition	OPTIONAL
MBB Blower unit with its suction filter and spare filter	OPTIONAL
Overflow Sensor	OPTIONAL
2x pH sensor and controller	OPTIONAL
Variable Frequency Driver	OPTIONAL

MAT MBB-360	MAT MBB-600	MAT MBB-800	MAT MBB-1300	MAT MBB-1500
74	132	245	350	450
121	172	150	241	275
K07R MD	K08R MD	K08R MD	K10 MD	E11 MD
EP66-0030 T3	EP66-0040 T3	EP66-0055 T3	EP66-0110 T3	EP66-0110 T3
5	9	16.3	23.3	30
3.23	5.81	10.76	15.4	20
2.94	5.28	9.78	14	18
410	650	1080	1800	2100
4900	8801	16301	25100	32100
PP food grade	PP food grade	PP food grade	PP food grade	PP food grade

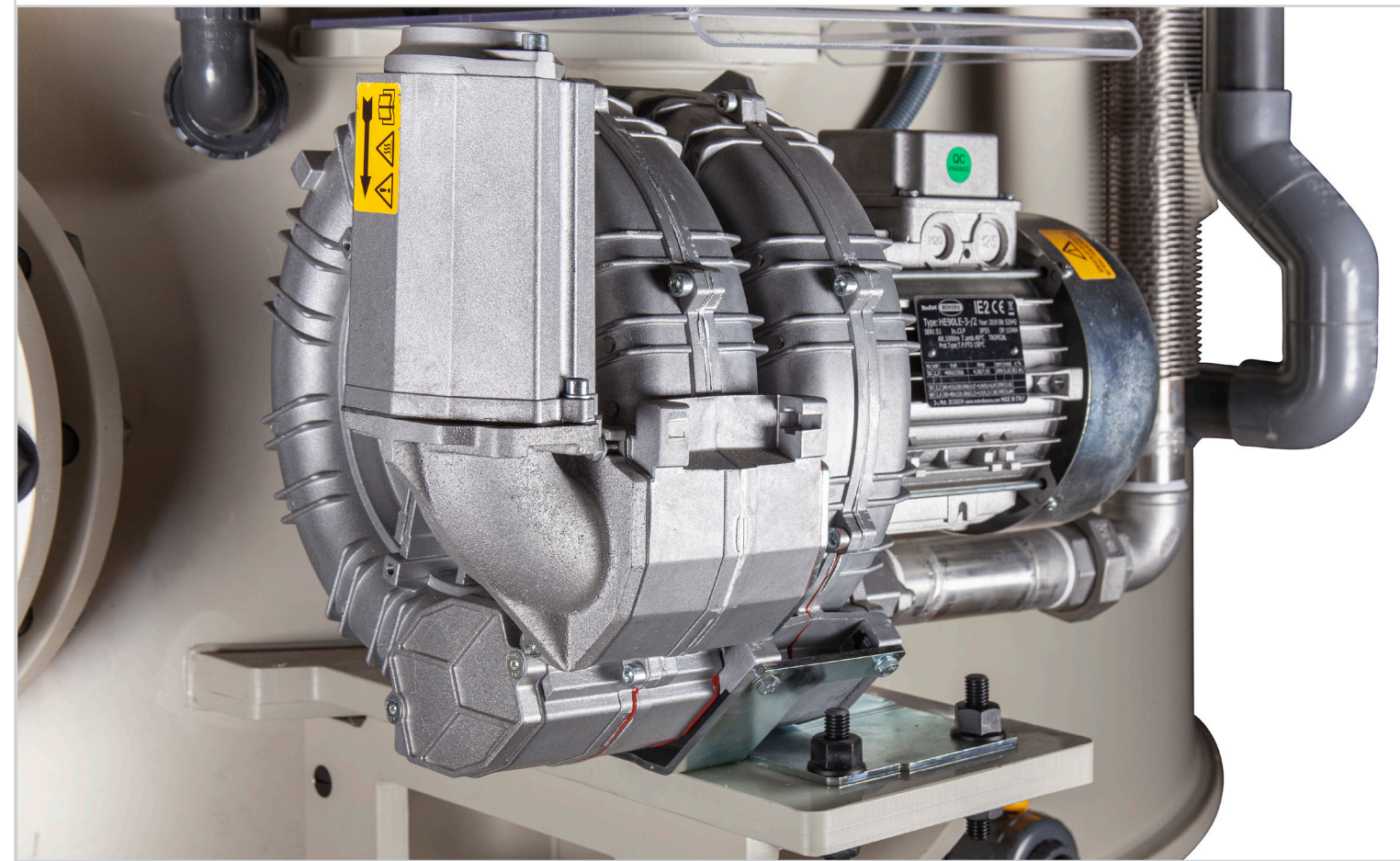



## TRICKLE FILTERS



Trickle filters are fixed media filters with cross flow of air and water. Trickle filters can be used with fan to source air to the system in an energy efficient way. Trickle filters are produced from drinking/food grade thermoplastic.

Trickle filters can be applied as biological filters in Biological filter in to remove ammonia and at the same time they extract CO<sub>2</sub> from the system. They are energy efficient; nitrification and CO<sub>2</sub> removal solution provide degassing affect along with ni- tri-fication of ammonia.



If the pupose is only to remove CO<sub>2</sub> from the system and aerate the water then, trickle filters are loaded with special degasification media to boost its CO<sub>2</sub> removal performance.





TRICKLE FILTER	DGS-22	DGS-62	DGS-220	DGS-280
Diameter [mm]	500	750	950	1250
Height [mm]	1561	1768	1835	2095
Dry Weight [kg]	70	131	203	285
Operational Weight [kg]	291	560	980	1420
Inlet Size [mm]	90	140	225	250
Outlet Size [mm]	90	140	225	250
Trickle Standpipe Level [mm]	1331	1518	1585	1845
Degas Blower Inlet Size [mm]	75	125	160	160
Max Water Flow Rate [m <sup>3</sup> /h]	22	62	220	280
Recomended 2 Minute Retention Water Flow [m <sup>3</sup> /h]	7.2	21.3	38.7	60
Max BIO-500 Media [m <sup>3</sup> ]	0.18	0.5	0.9	1.7
Body Material	PP	PP	PP	PP

#### TRICKLE FILTER (DEARATION TOWER/DE-GASS) OPTIONAL FEATURES

#### ALL MODELS

Overflow Switch	optional
Air Fan	optional
Air/Water Ratio On 2 Min Retantion Time	5/1
Biomedia BIO-100	optional
Biomedia BIO-500	optional

DGS-360	DGS-600	DGS-800	DGS-1300	DGS-1500
1500	2000	2350	3000	3400
2509	2865	2910	2910	2910
412	650	1080	2082	TBD
1950	3705	5650	9240	TBD
280	315	355	500	630
280	315	400	500	630
2420	2179	2250	2250	2250
160	200	200	225	250
360	600	800	1300	1500
135	242.7	330	614.7	TBD
3	5.2	7.5	12.8	15.8
PP	PP	PP	PP	PP



## DEGASSING TOWERS



Degas Towers are tailor made solutions for high density land based aquaculture tanks to extract excessive CO<sub>2</sub> from the water. MAT DGT provides an efficient means of carbon dioxide (CO<sub>2</sub>) and nitrogen (N<sub>2</sub>) gas removal, maintaining the suitable conditions of treated water to fish livestock.

The undesirable gases are diffused out of the water into the ambient with minimum energy consumption. The Unit offers three operation options:

- » Static flow trough
- » Two-phase atmospheric cross flow
- » Two-phase cross flow with vacuum

MAT Vacuum Degasser Systems operation

is based on the diffusional removal of undesirable gases and the enrichment of water in Oxygene by a fan and Titanium micron diffuser system. The gas exchange process is enhanced by the usage of a specifically dedicated blower that draws air into the water body. Air may flow atmospheric or under negative pressure -vacuum- depending on the operator's selection. On all options, air and water run in cross flow both through the media and the free-spaced columns for the maximum gas exchange efficiency.

MAT-KULING Degassers have unique auto clean wash and ozonated clean in place solution to avoid any kind of fouling.





DEGASS TOWER	DGT-25V	DGT-50V	DGT-100V	DGT-150V
Max Water Flow Rate (m <sup>3</sup> /hr)	25	50	100	150
Flow Rate @100 m/h HSL (m <sup>3</sup> /hr)	20	44	79	123
Flow Rate @75 m/h HSL (m <sup>3</sup> /hr)	15	33	59	92
Air Flow Nm <sup>3</sup> /hr	25 - 50	50 - 100	100 - 200	150 - 300
Air/Water Ratio G:L air/water	45323	45323	45323	45323
Operational Vacuum Pressure mBAR	100 - 150	100 - 150	100 - 150	100 - 150
Water inlet height mm	3100	3300	4315	4465
Water Outlet height mm	150	175	200	250
Tank height mm	3450	3650	4625	4780
Overall height mm	3600	3800	4775	5340
Water inlet diam. mm	140	160	200	225
Water outlet diam. mm	140	160	200	225
Cleaning Water Discharge Diamater (Gravity) mm	Ø75	Ø90	Ø110	Ø140
Cleaning Water Discharge Diamater (Pressure) inch	1 1/2"	1 1/2"	1 1/2"	1 1/2"
Tank Dia mm	500	750	1000	1250

DGT-300V	DGT-600V	DGT-900V	DGT-1200V
300	600	900	1200
201	434	638	829
151	325	478	622
300 - 600	600 - 1200	900 - 1800	1200 - 2400
45323	45323	45323	45323
100 - 150	100 - 150	100 - 150	100 - 150
4695	4940	5260	5700
300	375	475	550
4930	5250	5620	6060
5900	6200	6500	6940
315	400	500	710
315	400	500	710
Ø160	Ø160	Ø200	Ø225
1 1/2"	1 1/2"	1 1/2"	1 1/2"
1600	2350	2850	3250

DEGASS TOWER	DGT-25V	DGT-50V	DGT-100V	DGT-150V
Degassing Surface Area m <sup>2</sup>	0.2	0.44	0.79	1.23
Manhole diam. mm	Sight Glass	Sight Glass	Sight Glass	450
Emergency Oxygen Gas Inlet inch	1/2"	1/2"	1/2"	1/2"
Media Specific Surface Area m <sup>2</sup> /m <sup>3</sup>	140	140	140	140
Media Column Height cm	170	170	170	170
Media Volume m <sup>3</sup>	0.5	1.15	2.05	3.28
Air outlet diam. mm	75	75	110	140
Air inlet diam. mm	75	75	110	140
Auto clean pump model	21-40/55-56H	21-40/58H	21-40/58H	Normblock 65/250
Blower Installed Power kW	0.75	1.5	3	4
Cleaning Pump Installed Power kW	1.33	1.77	1.77	5.5
Cleaning VFD Model Model	EP66-0022 T3	EP66-0022 T3	EP66-0022 T3	EP66-0075 T3
Blower VFD Model Model	EP66-0007 T3	EP66-0015 T3	EP66-0030 T3	EP66-0040 T3
Blower Model	k04-ms	k05-ms	k07-ms	k075-ms

DGT-300V	DGT-600V	DGT-900V	DGT-1200V
2.01	4.34	6.38	8.29
450	450	450	450
3/4"	3/4"	1"	1"
140	140	140	140
170	170	170	170
5.3	11.73	17.1	22.15
200	250	315	500
200	250	315	500
Normblock 65/250	Normblock Multi 100/250	Normblock 125/250	Normblock 125/250
5.5	15	11 x 2	15 x 2
7.5	11	18.5	22
EP66-0110 T3	EP66-0150 T3	EP66-0220 T3	EP66-0300 T3
EP66-0055 T3	EP66-0150 T3	2 x EP66-0110 T3	2 x EP66-0150 T3
k10-ms	e11 ts	k09-ts x 2	e11 ts x 2



DEGASS TOWER	DGT-25	DGT-25H	DGT-50	DGT-50H	DGT-100	DGT-100H	DGT-150
Max Water Flow Rate ( m <sup>3</sup> /hr )	25	25	50	50	100	100	150
Flow Rate @100 m/h HSL (m <sup>3</sup> /hr)	20	20	44	44	79	79	123
Flow Rate @75 m/h HSL	15	15	33	33	59	59	92
Atmospheric Type Max Air Flow @5Mbar( Nm <sup>3</sup> /hr)	200	200	400	400	800	800	1200
Water inlet height ( mm )	2100	3100	2300	3300	3315	4315	3500
Water Outlet Height (mm )	150	150	175	175	190	200	250
Tank height (mm )	2450	3450	2650	3650	3625	4625	3900
Overall height (mm )	2600	3600	2800	3800	3845	4845	4200
Water inlet diam. (mm )	140	140	160	160	200	200	225
Water outlet diam. (mm )	140	140	160	160	200	200	225
Cleaning Water Discharge Diamater (Gravity) (mm )	Ø75	Ø75	Ø90	Ø90	Ø110	Ø110	Ø140
Cleaning Water Discharge Diamater (Pressure) (inch)	1 1/2 "	1 1/2 "	1 1/2 "	1 1/2 "	1 1/2 "	1 1/2 "	1 1/2 "
Tank Dia mm	500	500	750	750	1000	1000	1250
Degassing Surface Area (m <sup>2</sup> )	0.2	0.2	0.44	0.44	0.79	0.79	1.23
Manhole diam. mm	Sight Glass	Sight Glass	Sight Glass	Sight Glass	Sight Glass	Sight Glass	450

DGT-150H	DGT-300	DGT-300H	DGT-600	DGT-600H	DGT-900	DGT-900H	DGT-1200	DGT-1200H
150	300	300	600	600	900	900	1200	1200
123	201	201	434	434	638	638	829	829
92	151	151	325	325	478	478	622	622
1200	2400	2400	4800	4800	7200	7200	9600	9600
4500	3695	4695	3940	4940	4260	5260	4700	5700
250	270	300	328	375	445	475	550	550
4900	3930	4930	4250	5250	4620	5620	5060	6060
5200	5000	6000	5320	6320	5655	6655	5940	6940
225	315	315	400	400	500	500	710	710
225	315	315	400	400	500	500	710	710
Ø140	Ø160	Ø160	Ø160	Ø160	Ø160	Ø200	Ø200	Ø225
1 1/2 "	1 1/2 "	1 1/2 "	1 1/2 "	1 1/2 "	1 1/2 "	1 1/2 "	1 1/2 "	1 1/2 "
1250	1600	1600	2350	2350	2850	2850	3250	3250
1.23	2.01	2.01	4.34	4.34	6.38	6.38	8.29	8.29
450	450	450	450	450	450	450	450	450

DEGASS TOWER	DGT-25	DGT-25H	DGT-50	DGT-50H	DGT-100	DGT-100H	DGT-150
Emergency Oxygen Gas Inlet (inch)	1/2 "	1/2 "	1/2 "	1/2 "	1/2 "	1/2 "	1/2 "
Media Specific Surface Area (m2/m3)	140	140	140	140	140	140	140
Media Column Height (cm)	170	250	170	250	170	250	170
Media Volume (m3)	0.3	0.43	0.68	1	1.22	1.81	1.97
Air outlet diam. (mm)	110	110	140	140	160	200	200
Air inlet diam. (mm)	110	110	140	140	160	200	200
Auto clean pump model	21-40/55-56H	21-40/55-56H	21-40/58H	21-40/58H	21-40/58H	21-40/58H	Norm-block 65/250
Air Fan Installed Power (kW)	0.25	0.25	0.25	0.25	0.25	0.25	0.37
Cleaning Pump Installed Power (kW)	1.33	1.33	1.77	1.77	1.77	1.77	5.5
Cleaning VFD Model	EP66-0007 T3	EP66-0007 T3	EP66-0007 T3	EP66-0007 T3	EP66-0007 T3	EP66-0007 T3	EP66-0007 T3

DGT-150H	DGT-300	DGT-300H	DGT-600	DGT-600H	DGT-900	DGT-900H	DGT-1200	DGT-1200H
1/2 "	3/4 "	3/4 "	3/4 "	3/4 "	1 "	2 "	3 "	4 "
140	140	140	140	140	140	140	140	140
250	170	250	170	250	170	250	170	250
2.89	3.18	4.68	7.04	10.35	10.26	15.09	13.28	19.54
200	200	280	355	400	400	450	450	500
225	225	280	355	355	355	450	450	500
Norm-block 65/250	Norm-block 65/250	Norm-block 65/250	Norm-block Multi 100/250	Norm-block Multi 100/250	Norm-block Multi 125/250	Norm-block Multi 125/250	Norm-block Multi 125/250	Norm-block Multi 125/250
0.37	0.37	0.37	1.1	1.1	2.2	2.2	4	4
5.5	7.5	7.5	11	11	18.5	18.5	22	22
EP66-0007 T3	EP66-0007 T3	EP66-0007 T3	EP66-0015 T3	EP66-0015 T3	EP66-0022 T3	EP66-0022 T3	EP66-0040 T3	EP66-0040 T3

DGS OPTIONAL FEATURES	DGS-22 - DGS-1300
Overflow Switch	optional
Air Fan	optional
Air/Water Ratio On 2 Min Retention Time	5/1
Biomedica BIO-100	optional
Biomedica BIO-500	optional



DEGASS TOWER OPTIONAL FEATURES	DGT-25 - DGT-1200H
Blower (Vacuum Unit)	optional
Air Fan (Atmospheric Unit)	optional
Blower VFD	optional
pH sensor	optional
CO2 probes	optional
O2 probes	optional
Turbidity Probe	optional
Water level sensor	optional
Overflow sensor	optional
Cleaning Pump	optional
Manual Face Piping Valve Manifold	optional
Auto Clean System Motorized Face Piping Valve Manifold	optional
Electrical Control Panel	optional
PLC Automated Control Panel	optional





## DEGASSING SOLUTIONS OVERFLOW LAUNDERS



The Overflow Launder is a robust structural element built of PP (Polypropylene) and it allows the water to trickle and degas through its gradual flow design. It is used in industrial effluent wastewater treatment and in intensive land based fish farming applications as a degassing / aeration solution.

MAT-KULING manufactures custom overflow effluent launders according to each fish farm design specifications.

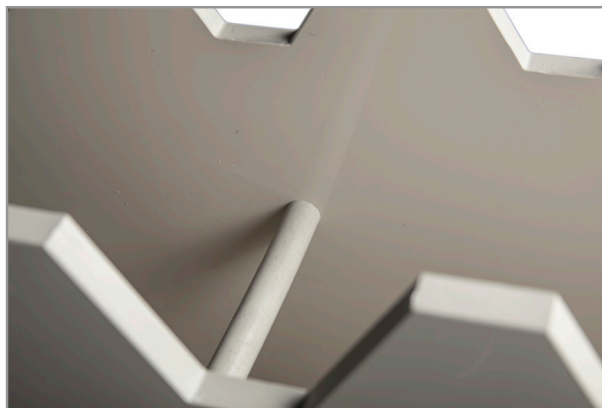
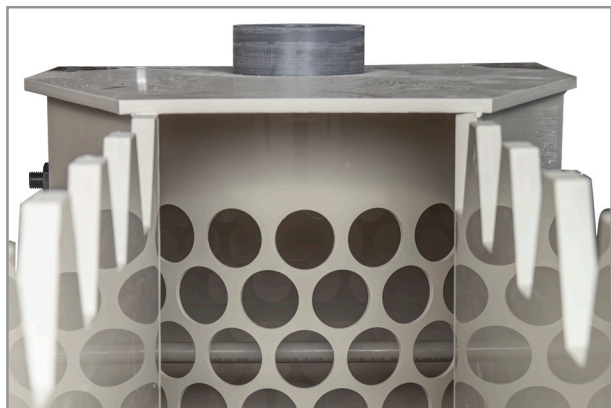
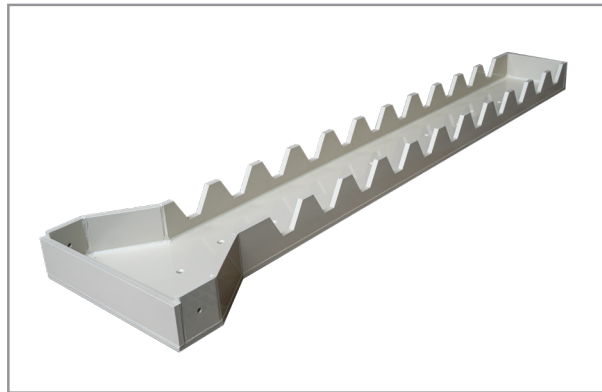
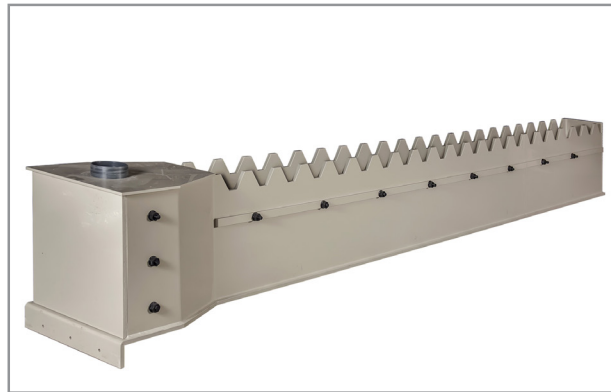

MODEL		LAU-custom
Launder Width (inner -bottom) mm	L	50
Theta rad		1063
Launder Entry Width (inner) mm	W	600
Launder Height mm	h	50
Launder Height (max) mm	D	85
Launder Length (max) mm		11500
Length between Notches mm		200
Flowrate per Launder m <sup>3</sup> /hr		1300
Flowrate Through Notch m <sup>3</sup> /hr		4,13
Wet Weight (max) kg		3750
Dry Weight (max) kg		260



## FOAM EXTRACTORS



MAT-KULING FE Unit is a Foam Extractor System used to extract the thick foam from Very Large Protein Skimmer Collector Heads via a special water lock where any possible remained ozone gas is separated from foam and is diverted to the ozone outlet.

The Foam Extractor consists of a tower and a waste gas blower that forms the subpressure to pull the waste gas out of the tower column.

The extractor inlet is secured against backflows and the water exit includes a siphon to ensure water is kept at the designed level.



FOAM EXTRACTOR	FEX-100	FEX-400	FEX-800	FEX-1200
Diameter mm	500	750	1000	1500
Height mm	2085	2270	2400	2590
Volume m <sup>3</sup>	0.35	0.75	1.57	4.59
Dry Weight kg	110	150	185	250
Operational Weight (Kg)	245	350	586	1300
Water/Gas Inlet Diameter (mm)	63	90	110	160
Water Discharge Diameter (mm)	40	75	90	110
Max Water Flow Rate (m <sup>3</sup> /hr)	3	8	15	30
Max Gas Flow @-100Mbar Nm <sup>3</sup> /hr	100	300	600	1200
Blower model	K04MS	K08 MS	e11 MS	K09 TS
Blower Max Power (kW)	0.75	3	7.5	11
VFD model	EP66-0007-T3	EP66-0030 T3	EP66-0075 T3	EP66-0110 T3

FOAM EXTRACTOR	FEX-300 - FEX 1200
Diameter mm	optional
Height mm	optional
Volume m <sup>3</sup>	optional
Dry Weight kg	optional
Operational Weight (Kg)	optional
Water/Gas Inlet Diameter (mm)	optional

FOAM EXTRACTOR	FEX-300 - FEX 1200
Water Discharge Diameter (mm)	optional
Max Water Flow Rate (m <sup>3</sup> /hr)	optional
Max Gas Flow @-100Mbar Nm <sup>3</sup> /hr	optional
Blower model	optional
Blower Max Power (kW)	optional
VFD model	optional



# OZONE DESTRUCT SYSTEMS



MAT-KULING Ozone Destruct Units offer the solution for the safe and rapid destruction of ozone and should be a core element of a proper ozone generator installation in confined mechanical room.

We produce either activated carbon or thermal catalytic types of Ozone Destruct Units.

Thermal Catalytic Ozone Destruct Units are ideal for large ozone production plants for superior safety and less space requirement.

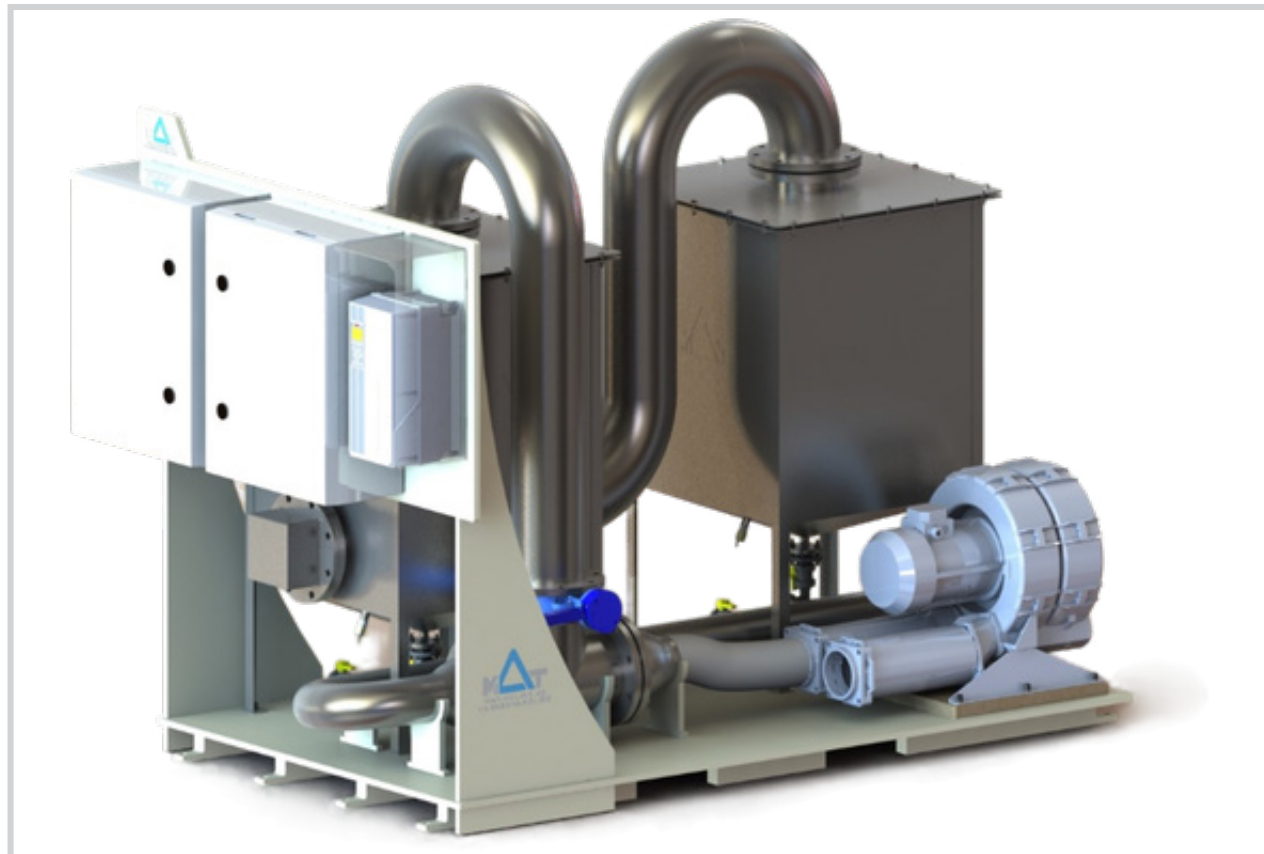

OZONE DE-STRUCT CATALYSIS	ODT-1	ODT-5	ODT-10	ODT-25	ODT-50
Flow rate ( Nm <sup>3</sup> /h )	1	5	10	25	50
Footprint Width [mm]	450	500	775	950	950
Footprint Depth [mm]	180	220	1350	1200	1200
Max Height [mm]	1200	1460	82	1820	1820
Dry Weight ( kg )	11	22	35	185	185
Demister/Destructor Material	316 SS	316 SS	316 SS	316 SS	316 SS
Chasis Material	N/A	N/A	PP or GRP	PP or GRP	PP
Pipeline Material	U-PVC and 316 SS	U-PVC and 316 SS	U-PVC and 316 SS	U-PVC and 316 SS	U-PVC and 316 SS
Electrical Connection	1Phase + Neutral + PE	1Phase + Neutral + PE	3Phase + Neutral + PE	3Phase + Neutral + PE	3Phase + Neutral + PE
Installed Power [kW]	0.1	0.15	0.8	1.15	2
Supply Voltage 50/60 Hz [V]	1~230	1~230	3~400	3~400	3~400
Nominal Current (A)	0.48	0.72	1.28	1.85	3.21
Heater Power (kW)	0.1	0.15	0.4	0.75	1.25
Residual Ozone Line Connection [mm]	DN15	DN25	DN25	DN32	DN50

ODT-100	ODT-200	ODT-400	ODT-800	ODT-1200	ODT-2000
100	200	400	800	1200	2000
1000	1050	1200	1900	1550	1750
1160	1285	1435	1200	2840	1865
1820	1820	1845	2000	2115	2480
225	250	357	420	670	800
316 SS	316 SS	316 SS	316 SS	316 SS	316 SS
PP	PP	PP	PP or GRP	PP or GRP	PP or GRP
U-PVC and 316 SS	U-PVC and 316 SS	U-PVC and 316 SS	U-PVC and 316 SS	U-PVC and 316 SS	U-PVC and 316 SS
3Phase + Neutral + PE	3Phase + Neutral + PE	3Phase + Neutral + PE	3Phase + Neutral + PE	3Phase + Neutral + PE	3Phase + Neutral + PE
3.5	5.5	10	21.5	26.5	45
3~400	3~400	3~400	3~400	3~400	3~400
5.62	8.83	16.06	34.52	42.55	72.25
2	3	5.5	10	15	22
DN80	DN100	DN125	DN110	DN150	DN200



OZONE DE-STRUCT CATALYSIS	ODT-1	ODT-5	ODT-10	ODT-25	ODT-50
Off-Gass Outlet Connection [mm]	DN15	DN25	DN25	DN32	DN40
Destructor Inlet Max Ozone Concentration %wt	3	3	3	3	3
Destructor Outlet Max Ozone Concentration(ppm)	<0,1	<0,1	<0,1	<0,1	<0,1
Demister Drain Connection [mm]	DN15	DN15	DN20	DN20	DN20
Carulite Media Quantity [kg]	1	2	3	6	10
Blower Model (Recommended)	N/A	N/A	O6R MS	O6R MS	K03 MS
Blower Power @-50mbar, 50/60Hz. kW	N/A	N/A	0.2	0.2	0.37
Blower Quantity pcs.	N/A	N/A	1	1	1
Max Suction Pressure @ Duty Point (mBAR)	N/A	N/A	-140	-140	-140
Variable Frequency Driver Model vfd	N/A	N/A	EP66-0007 T3	EP66-0007 T3	EP66-0007 T3
Max Temperature Increase caused by Heater °C	12	12	12	12	12

ODT-100	ODT-200	ODT-400	ODT-800	ODT-1200	ODT-2000
DN50	DN50	DN80	DN110	DN150	DN200
3	3	3	3	3	3
<0,1	<0,1	<0,1	<0,1	<0,1	<0,1
DN20	DN20	DN20	DN32	DN32	DN32
20	40	75	155	225	375
K04 MS	K06 MS	K08 MS	e11 MS	K09 TS	K09 TS x 2
0.75	2.2	3	7.5	11	11 x 2
1	1	1	1	1	2
-140	-140	-140	-150	-140	-150
EP66-0007 T3	EP66-0022 T3	EP66-0030 T3	EP66-0075 T3	EP66-0110 T3	2 X EP66-0110 T3
12	12	12	12	12	12

OZONE DE-STRUCT CATALY-SIS	ODT-1	ODT-5	ODT-10	ODT-25	ODT-50
Thermal Catalytic Ozone Destruct Control Board	Optional	Optional	Optional	Optional	Optional
Thermal Catalytic ODT Blower	N/A	N/A	Optional	Optional	Optional
Thermal Catalytic ODT Blower VFD	N/A	N/A	Optional	Optional	Optional
Temperature Probe with standard probe cable	Optional	Optional	Optional	Optional	Optional
Corrosion Resistant Sensor -1...9bar (4-20mA)	Optional	Optional	Optional	Optional	Optional
Overflow Level Sensor	Optional	Optional	Optional	Optional	Optional
Thermal Catalytic ODT PLC Controller	Optional	Optional	Optional	Optional	Optional

ODT-100	ODT-200	ODT-400	ODT-800	ODT-1200	ODT-2000
Optional	Optional	Optional	Optional	Optional	Optional
Optional	Optional	Optional	Optional	Optional	Optional
Optional	Optional	Optional	Optional	Optional	Optional
Optional	Optional	Optional	Optional	Optional	Optional
Optional	Optional	Optional	Optional	Optional	Optional
Optional	Optional	Optional	Optional	Optional	Optional
Optional	Optional	Optional	Optional	Optional	Optional



OZONE DESTRUCT	ODC-6	ODC-25
Footprint Width [mm]	510	655
Footprint Depth [mm]	460	550
Max Height [mm]	1110	1390
Body Diameter [mm]	250	315
Body Material	PP	PP
Installed Power [kW]	0.25	0.25
Supply Voltage 50 Hz [V]	3~400/230	3~400/230
Residual Ozone Line Connection [mm]	50	75
Off-Gass Outlet Connection [mm]	75	110
Water Drain Connection [mm]	40	50
Activated Carbon Media Quantity [L]	20	40
Max Gas Inlet Ozone concentration %wt	1	1
Max Gas Outlet Ozone Concentration ppm	0,1	0,1
Water Trap/Drain Column	Standart	Standart
Blower [model]	G2E120-AR77-01	G2E140-AE77-01

ODC-50	ODC-100	ODC-200
750	825	955
680	760	890
1430	1490	1490
400	500	630
PP	PP	PP
0.25	0.25	0.25
3~400/230	3~400/230	3~400/230
90	90	90
110	125	140
63	75	75
60	110	200
1	1	1
0,1	0,1	0,1
Standart	Standart	Standart
G2E160-AY47-01	G2E180-EH03-01	G2E180-EH03-01



## OZONE CONTACT & OZONE DOSING SKIDS



Ozone is a gas that needs to be infused into water under a compressed infusion process, in multiple points of a filtration system. In saline water, protein fractionators (skimmers) are traditionally used to achieve this through a venturi device, infusing ozone mixed with air into the water column.

Latest developments have shown us that the infusion of ozone is not best achieved only by using this venturi infusion. Thus, a mixing and contact tank is required and in some applications, a pressurized vessel needs to be implemented to infuse ozone

into the water column under a pressurized mixture.

MAT-KULING has two types of injection units:

ODS series is for Low-Pressure Ozone Injection through pipes, header or atmospheric contact tanks. OCS series is for high-pressure ozone diffusing through a pressurized mixing and contact chamber.

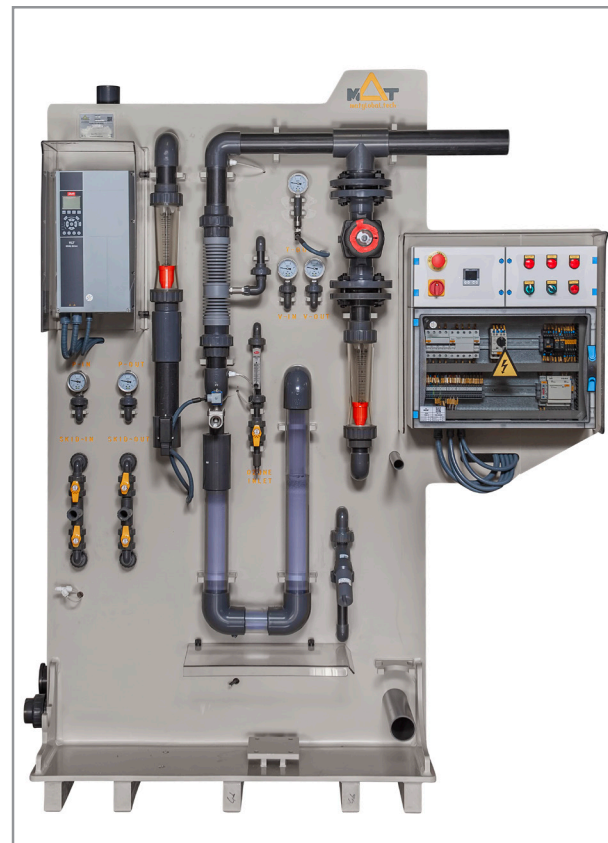



OZONATION SKID FOR MARINE/ FRESH WATER	OCS-10	OCS-20
Footprint Depth [mm]	1150	1300
Footprint Width [mm]	1850	1860
Max. Height [mm]	2600	2600
Contact Tank Diameter [mm]	600	800
Installed Power [kW]	3	3
Basic Unit Total Electric Consumption [kWh]	1.95	2.21
Supply Voltage (50Hz) [V]	3~400/230	3~400/230
Inlet Size [mm]	50	63
Outlet Size [mm]	40	50
Contact Time [min]	5	5
Ozone Concentration [ppm]	0,5-2	0,5-2
Ozone Dosing [g/h]	10	20
Ozone Dosing [L/min]	4.5	5
CT Value	10	10
Booster Pump Material	PP	PP
Pressure Sensor TANK-IN	YES	YES
Pump Model	CMO-N 40-160	CMO-N 40-160
Pump Variable Frequency Driver Model	EP66-0055 T3	EP66-0055 T3
Ozone Contact Tank Model/ Cylinder height	R60C/1700	R80C/1700
Ozone Contact Tank Total Height [mm]	2270	2350

OCS-50	OCS-100	OCS-150	OCS-250
1430	1800	2020	2465
3950	4745	5175	5925
2980	2900	3500	3385
1200	1600	1800	2200
5.5	11	11	18.5
4.22	8.5	9.48	16.08
3~400/230	3~400	3~400	3~400
110	140	160	200
90	140	160	200
5	5	5	5
0,5-2	0,5-2	0,5-2	0,5-2
50	100	150	250
10	39	49	40
10	10	10	10
PP	PP	PP	PP
YES	YES	YES	YES
CMO-N 40-160	CMO-N 65-160	CMO-N 65-160	CDI-QL 100-80-160
EP66-0055 T3	EP66-0110 T3	EP66-0150 T3	EP66-0220 T3
R120C/1700	R160C/1700	R180C/2000	R220C/2000
2550	2750	3150	3350

OZONATION SKID FOR MARINE/ FRESH WATER		
	OCS-10	OCS-20
Dry Weight (kg)	180	250
Ozone Destruct	STANDARD	STANDARD
Max Line Pressure [bar]	1,7	1,9
Pump Flow Rate [m <sup>3</sup> /h]	5	10
Venturi Inlet Pressure [bar]	3	3
Tank Operating Pressure [bar]	1,9	2,1
Ozone GAS Suction Rate [L/min]	4,5	5

OCS OPTIONAL FEATURES	OCS-10 - OCS-250
Pressure Probe TANK-OUT	optional
PH/ORP Probe & Fittings	optional
DO3 PROBE & Fitting	optional
Control Board	optional
Control Board with PLC	optional
Ambient Ozone Monitor	optional

OCT TANKS	OCT-10	OCT-20	OCT-50
Description	OZONE CON- TACT TANK	OZONE CON- TACT TANK	OZONE CON- TACT TANK
Material	FRP	FRP	FRP
Type	Vertical	Vertical	Vertical
Diameter/ Footprint Size mm	1700	1700	1700
Height mm	2270	2350	2550
Tank Volume m3	0,45	0,85	2,5
Nominal Operational Pressure bar	2,5	2,5	2,5
Maximum Permitted Pressure bar	6	6	6

OCS-50	OCS-100	OCS-150	OCS-250
460	1250	1420	1875
STANDARD	STANDARD	STANDARD	STANDARD
1,7	1,7	1,7	1,7
25	50	75	125
3	3	3	3
1,9	1,9	1,9	1,9
10	39	49	40

OCS OPTIONAL FEATURES	OCS-10 - OCS-250
FRP Body Ozone Contact Tank	optional
Ozone Contact Skid Pump	optional
Ozone Contact Skid Pump VFD	optional
Ozone Dosing Skid Digital Flowmeter	optional
Automatic Air Purge 1"	optional
Automatic Air Purge 2"	optional
Pressure Relief Valve	optional

OCT-100	OCT-150	OCT-250	OCT-500	OCT-1000
OZONE CON- TACT TANK	OZONE CON- TACT TANK	OZONE CON- TACT TANK	OZONE CON- TACT TANK	OZONE CON- TACT TANK
FRP	FRP	FRP	FRP	FRP
Vertical	Vertical	Vertical	Vertical	Vertical
1700	2000	2000	TBD	TBD
2750	3150	3350	TBD	TBD
4,5	6,5	11	TBD	TBD
2,5	2,5	2,5	2,5	2,5
6	6	6	6	6



OZONE DOSING SKID FOR MARINE/ FRESH WATER	ODS-10	ODS-20	ODS-50
Footprint Depth [mm]	700	700	700
Footprint Width [mm]	1135	1135	1140
Max. Height [mm]	2130	2130	2130
Installed Power [kW]	1,1	1,1	1,3
Supply Voltage (50Hz) [V]	3~400/230	3~400/230	3~400/230
Inlet Size [mm]	50	50	50
Outlet Size [mm]	50	50	50
Ozone Dosing [g/h]	10	20	50
Ozone Dosing [L/min]	4,5	6	10
Pump Model pump	21-40/53 H	21-40/53 H	21-40/54 H
Max Outlet Pressure (Higher pressures possible with custom design) [bar]	0,7	0,7	0,7
Inlet/outlet pressure monitors gauge/bar	1--4	1--4	1--4
Pump Flow Rate @ Max line pressure [m <sup>3</sup> /h]	7,3	7,3	7,7
Ozone GAS Suction Rate @ Max line pressure [L/min]	5	6	10
Venturi Model vnt	250M	260M	260M

ODS-100	ODS-250	ODS-500	ODS-1000
700	700	700	800
1270	1270	1750	1900
2180	2230	2500	2500
2,2	2,2	3,7	4,8
3~400/230	3~400/230	3~400/230	3~400
63	63	90	110
63	63	90	110
100	250	500	1000
39	40	80	160
21-40/58 G	21-40/58 G	21-60/46 G	21-80/34 G
0,7	0,7	0,7	0,7
1--4	1--4	1--4	1--4
14	14	40	63
39	40	80	160
350M	350M	430M	600M

**OZONE DOSING SKID FOR MARINE/ FRESH WATER OPTIONAL FEATURES**

	ODS-10	ODS-20	ODS-50
Variable Frequency Driver vfd	EP66-0015 T3	EP66-0015 T3	EP66-0015 T3
ORP/PH Probe & Probe Fitting	optional	optional	optional
DO3 Probe & Probe Fitting	optional	optional	optional
Control Board	optional	optional	optional
Digital pressure probes	optional	optional	optional
PLC Control	optional	optional	optional
Ozone Ambient Detector	optional	optional	optional
ODS Booster Pump	optional	optional	optional
Digital Flowmeter	optional	optional	optional

ODS SPECIFICATIONS

ODS-100	ODS-250	ODS-500	ODS-1000
EP66-0022 T3	EP66-0022 T3	EP66-0040 T3	EP66-0055 T3
optional	optional	optional	optional
optional	optional	optional	optional
optional	optional	optional	optional
optional	optional	optional	optional
optional	optional	optional	optional
optional	optional	optional	optional
optional	optional	optional	optional
optional	optional	optional	optional

ODS SPECIFICATIONS





## PRESSURIZED MEDIA FILTER SKIDS & FILTER TANKS



Filter Tanks are generally filled in with Glass Filter Media instead of silica sand, for multiple advantages and advanced performance.

The PMF Skid System is a complete plug-and-play water treatment solution. PMF Skid Systems are sold hydro-tested and fully assembled.

Complete ease of operation and low energy consumption. The unit includes top-notch mechanical filtration with powerful disinfection.

### PMF SKID FEATURES:

- » Pressurised Mechanical Filter Tank
- » Circulation Pump
- » UV-C Sterilizer
- » Piping & Valves
- » Flow Meters
- » Plate Heat Exchanger
- » Chemical Dosage & Controller
- » Variable Pump motor drivers
- » Pressure sensors
- » Temperature Monitoring

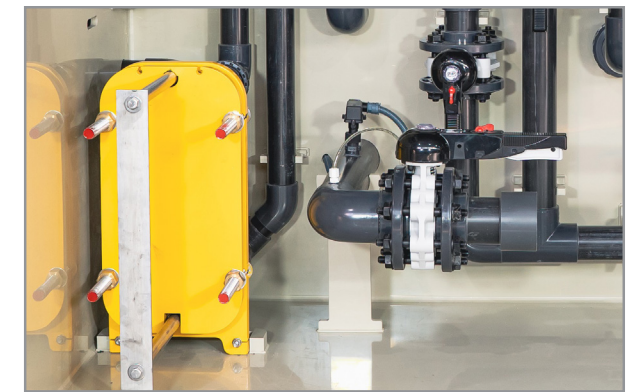



PMF SKID	PMF-4	PMF-12	PMF-22
Footprint Width [mm]	2200	3100	3500
Footprint Length [mm]	830	1400	1400
Unit Height [mm]	2060	2250	2200
Recommended Room Height [mm]	3000	3000	3000
PMF Tank Diameter & Area [mm]	500	830	1000
PMF Tank Diameter & Area [m <sup>2</sup> ]	0,19	0,5	0,79
Installed Power [kW]	0,75	1,77	2,55
Basic Unit Total Electric Consumption [kWh]	0,65	1,5	2,2
Supply Voltage (50Hz) [V]	3~400/230	3~400/230	3~400/230
Skid Inlet [mm]	50	75	90
Skid Outlet [mm]	50	63	75
Backwash Inlet Size [mm]	40	63	75
Nominal Flowrate [m <sup>3</sup> /h]	5	11	21
Dry Weight [kg]	450	765	950
System Pump Model	Speck Prime 13 AK	Speck Prime 30 AK	Speck Prime 40 AK
System Pump Driver Model	EP66-0022 T3	EP66-0022 T3	EP66-0022 T3

PMF-38	PMF-50	PMF-64	PMF-80
4300	4830	5000	5300
1620	1850	2100	2600
2300	2400	2600	2700
4500	4500	5000	5000
1400	1600	1800	2000
1,54	2,01	2,54	3,14
3,8	4,8	6,4	6,4
3,25	4	5,5	5,5
3~400/230	3~400	3~400	3~400
140	160	160	200
110	140	140	160
110	110	125	140
38	50	63	78
1250	1550	1850	2100
Speck Resort 50 AK	Speck Resort 80 AK	Speck Resort 110 AK	Speck Resort 110 AK
EP66-0040 T3	EP66-0040 T3	EP66-0055 T3	EP66-0055 T3



PMF SKID OPTIONAL FEATURES	PMF-4	PMF-12	PMF-22
AUTOMATIC BACKWASH	PNEUMATIC/MOTORISED		
Temperature Sensor	OPTIONAL	OPTIONAL	OPTIONAL
TITANIUM HEAT EXCHANGER	OPTIONAL	OPTIONAL	OPTIONAL
Titanium Heat Exchanger Capacity [kWh]	3/5	5/10	15/20
ELECTRICAL TITANIUM HEATER	OCDV6	OCDV9	OCDV15
Electrical Heater Capacity [kWh]	6	9	15
PLC CONTROL	OPTIONAL	OPTIONAL	OPTIONAL
UV DISINFECTION	UV 5	UV 10	UV 20
AUTOMATIC CHEMICAL CONTROL & DOSING SYSTEM	POOL GUARD Include Chemical Regulator Pumps & PH/ORP Probes		
Disinfection System Footprint Width [mm]	950	950	1100
Disinfection System Footprint Depth [mm]	500	500	500

PMF SPECIFICATIONS

PMF-38	PMF-50	PMF-64	PMF-80
PNEUMATIC/MOTORISED			
OPTIONAL	OPTIONAL	OPTIONAL	OPTIONAL
OPTIONAL	OPTIONAL	OPTIONAL	OPTIONAL
20/40	25/50	30/75	50/100
OCDV24	OCDV24	2 x OCDV24	2 x OCDV24
24	24	48	48
OPTIONAL	OPTIONAL	OPTIONAL	OPTIONAL
UV 50	UV 50	UV 100	UV 100
POOL GUARD Include Chemical Regulator Pumps & PH/ORP Probes			
1200	1200	1200	1200
600	600	600	600

PMF SPECIFICATIONS

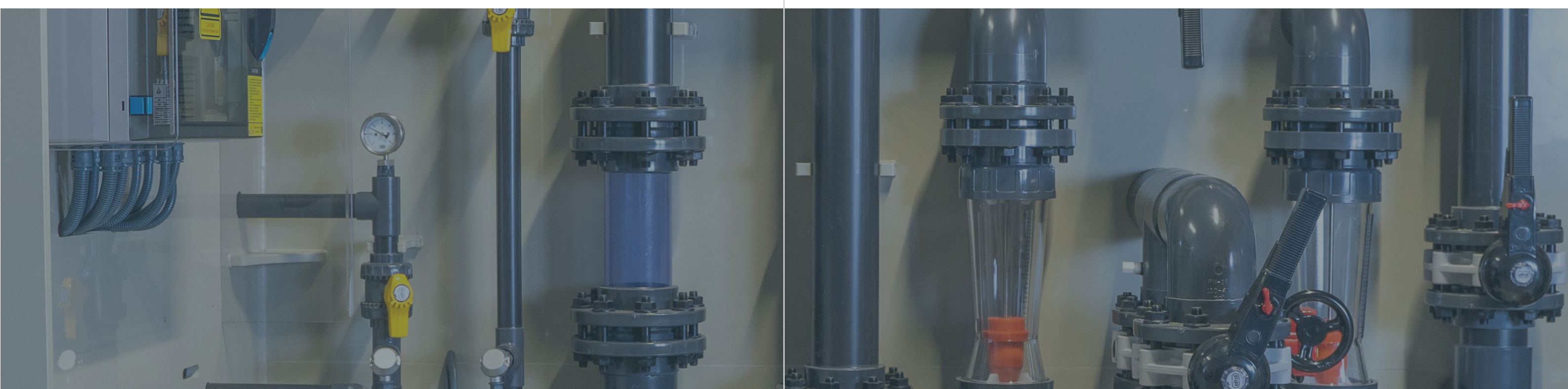

TANK MODEL NUMBER	FT-500	FT-830	FT-900
Material	GRP	GRP	GRP
Type	Vertical	Vertical	Vertical
Diameter/ Footprint Size mm	500	830	900
Height mm	1605	1770	1730
Tank Volume m <sup>3</sup>	0.4	1.23	1.42
FLOWRATE m <sup>3</sup> /h	4.75	13.5	16
FILTRATION SPEED m <sup>3</sup> /h/m <sup>2</sup>	25	25	25
FILTRATION AREA m <sup>2</sup>	0.2	0.5	0.64
CONNENCTION FLNGED/UNION	UNION	UNION	UNION
CONNENCTION SIZE mm	50	63	63
SAND MEDIA DEPTH mm	1000	1000	1000
TOTAL SAND MEDIA CAPACITY Kg	276	743	885
Nominal Operational Pressure bar	2.5	2.5	2.5
Design Pressure	3.5	3.5	3.5

FT-1000	FT-1200	FT-1400	FT-1600	FT-1800	FT-2000
GRP	GRP	GRP	GRP	GRP	GRP
Vertical	Vertical	Vertical	Vertical	Vertical	Vertical
1000	1200	1400	1600	1800	2000
1310	1410	1560	1860	2050	2160
1.37	1.05	1.6	2.5	3.6	4.8
19.8	28.3	38.5	50.3	63.5	78.5
25	25	25	25	25	25
0.79	1.13	1.54	2.01	2.54	3.14
UNION	FLANGED	FLANGED	FLANGED	FLANGED	FLANGED
75	90	110	125	140	160
1000	870	1000	1200	1280	1380
1075	1316	2085	3245	4308	5844
2.5	2.5	2.5	2.5	2.5	2.5
3.5	3.5	3.5	3.5	3.5	3.5



TANK MODEL NUMBER	FT-2200	FT-2400	FT-2X2.5
Material	GRP	GRP	GRP
Type	Vertical	Vertical	Horizontal
Diameter/ Footprint Size mm	2200	2400	2000x2500(L)
Height mm	2360	2660	2300
Tank Volume m <sup>3</sup>	6.7	8.8	6.9
FLOWRATE m <sup>3</sup> /h	95	108	102
FILTRATION SPEED m <sup>3</sup> /h/m <sup>2</sup>	25	25	25
FILTRATION AREA m <sup>2</sup>	3.8	4.34	4.1
CONNENCTION FLNGED/UNION	FLANGED	FLANGED	FLANGED
CONNENCTION SIZE mm	160	160	160
SAND MEDIA DEPTH mm	1380	1380	1000
TOTAL SAND MEDIA CAPACITY Kg	5700	6510	7380
Nominal Operational Pressure bar	2.5	2.5	2.5
Design Pressure	3.5	3.5	3.5

FT-2X3	FT-2X4	FT-2X5
GRP	GRP	GRP
Horizontal	Horizontal	Horizontal
2000x3000(L)	2000x4000(L)	2000x5000(L)
2300	2300	2300
8.5	11.3	14
125	170	221
25	25	25
5	7	8.8
FLANGED	FLANGED	FLANGED
160	225	225
1000	1000	1000
9000	12600	15840
2.5	2.5	2.5
3.5	3.5	3.5

## THERMO-PLASTIC BASKET STRAINERS / PRE-FILTERS



MAT-KULING manufactures corrosion-resistant pump strainers/pre-filters to not only protect pumps but also other downstream equipment in any part of the process.

The Thermo-Plastic Strainers are a specially designed and manufactured product to serve in harsh and corrosive conditions. They have the ideal fabrication material for acidic and corrosive liquids. They offer protection to pumps and the various elements of an installation, with minimized maintenance needs thanks to quick open cover for cleaning.

MAT-KULING Strainers are produced in Polypropylene but they can be also produced in Polyethylene. The standard aquaculture Strainer mesh size is 5mm but can be adjusted as per the request.

The complete visible acrylic cover and the quick open/close mechanism that allows open /close the strainer in seconds are the main advantages.

Standard Strainers are being manufactured up to 600m<sup>3</sup>/h but custom models can be produced up to 2000m<sup>3</sup>/h.





BASKET STRAINER	BSF-50	BSF-85
Flange Size A	DN 100	DN 125
Height B [mm]	800	850
Inlet Level C [mm]	365	400
Outlet Level D [mm]	160	220
Body Diameter E [mm]	400	400
Max. Width F [mm]	620	630
Max Flow Rate [m <sup>3</sup> /h]	50	85
Mesh Size [mm]	5	5
Vmin [m/s]	0,5	0,5
V nominal [m/s]	1,0	1,0
Vmax [m/s]	2,0	2,0
Pressure Loss (Vnom) [mbar]	50,0	52,9
Mesh / Pipe Opening ratio	1/ 4,3	1/ 4,3
Maximum Working pressure [bar]	2.5	2.5
Working temperature range [C°]	10--40	10--40
Dry Weight [kg]	40	44
Operational Weight [kg]	115	120
Material	PP	PP
Inlet and Outlet Manometers	Optional	Optional

BSF-115	BSF-220	BSF-430	BSF-650
DN 150	DN 200	DN 300	DN 350
900	1000	1254	1456
420	545	775	960
250	270	280	577
400	400	500	500
640	650	760	780
115	220	430	650
5	5	5	5
0,5	0,5	0,5	0,5
1,0	1,0	1,0	1,0
2,0	2,0	2,0	2,0
55,9	50,0	50,0	70,6
1/ 4,3	1/ 4,3	1/ 4,3	1/ 4,3
2.5	2.5	2.5	2.5
10--40	10--40	10--40	10--40
48	53	113	122
125	130	290	325
PP	PP	PP	PP
Optional	Optional	Optional	Optional

## STATIC SCREEN FILTERS



The Static Screen filter, known as the static sieve, separates solid and liquid substances within Waste Water Treatment applications. It serves two primary purposes:

- » It serves as the initial treatment for wastewater, utilizing a mesh size ranging from 0.5mm to 10mm.
- » It is a pre-treatment solution for the solid-liquid waste separation process.

The application is particularly effective in removing thick waste from industries such as paper, textiles, tanning, laundry, canning, milk processing, and slaughter-

houses, aquaculture, and food processing facilities among others. The static screen offers a cost-effective solution for the continuous solid-liquid separation process, requiring minimal maintenance and consuming zero energy. Its composition primarily comprises a body and the mesh frame crafted from food and drinking grade non corrosive Polypropylene and Polyethylene.

### **MAT-KULLING Static Screen Filters Options:**

- » Sieve Lid/Cover



- » Mechanical Manual Sieve/Mesh Cleaning
- » Mechanical Auto Sieve/Mesh Cleaning
- » Auto wash Sieve/Mesh Cleaning
- » Different body and mesh material
- » Solid Collection Hooper

### **MAT-KULLING Static Screen Filters usage offers various advantages such as:**

- » Corrosive free and robust product construction.
- » Assembly built to withstand harsh operational conditions and ozone and chemical attacks, ensuring long-lasting operation.

- » Combination of a front and back cleaned screen in a single unit (Optional).
- » Adjustable Optimized Rinsing System with means of both Water Level Difference and Timer to conserve water (Optional).
- » Low cost for maintenance and operation.
- » Designed with the ability to provide tailor-made solutions that match each project-specific need.
- » Eco-friendly solution with recycled material and low CO2 footprint.



STATIC SCREEN MODEL	SSF-1	SSF-2
Piping Connections (DN) Inlet Dia	110	110
Piping Connections (DN) Outlet Dia	150	200
Piping Connections (DN) Drain Dia	110	110
Physical Dimensions (mm) A	500	1050
Physical Dimensions (mm) L	1267	1267
Physical Dimensions (mm) W	715	1265
Physical Dimensions (mm) H	1486	1486
Weight (Kg)	92	130
Max. Capacity (m <sup>3</sup> /h) Aperture = 1 mm	21	42
Max. Capacity (m <sup>3</sup> /h) Aperture = 2 mm	41	80
Max. Capacity (m <sup>3</sup> /h) Aperture = 3 mm	50	100

SSF-3	SSF-4	SSF-5
150	150	200
250	300	400
150	150	200
1680	2100	3150
1325	1325	1325
1895	2350	3350
1635	1635	1635
305	315	470
63	84	126
124	164	246
150	200	300

# RAS & COMPACT SKID FILTRATION SYSTEMS



The MAT-KULING Recirculating aquaculture skid filtration systems are tailor-made complete filtration units designed for simple Recirculating Aquaculture operation, with the smallest footprint and minimum energy consumption.

The units are equipped to provide complete mechanical, biological, organic removal treatments along with disinfection and aeration/oxygen enrichment based on the requirements of the applications.

Plug and Play Skid Units are fully tested in the factory before delivery.

Compact units are standard products for low-bio load applications.

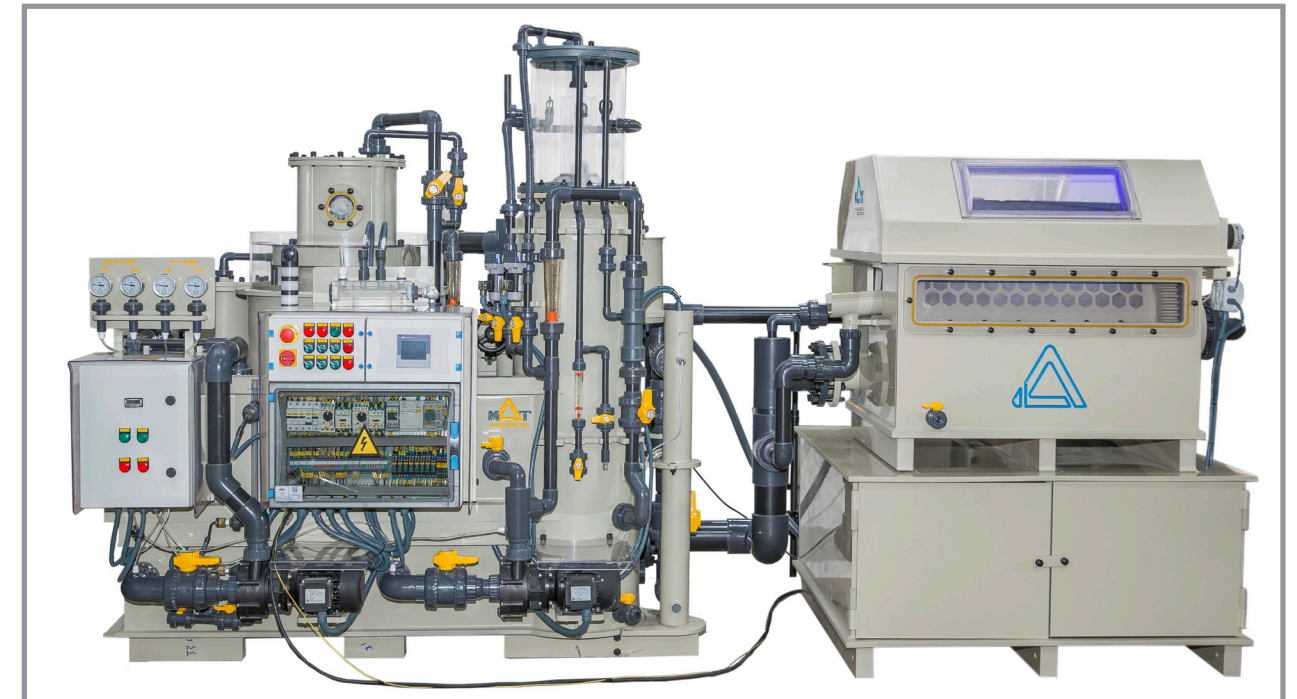



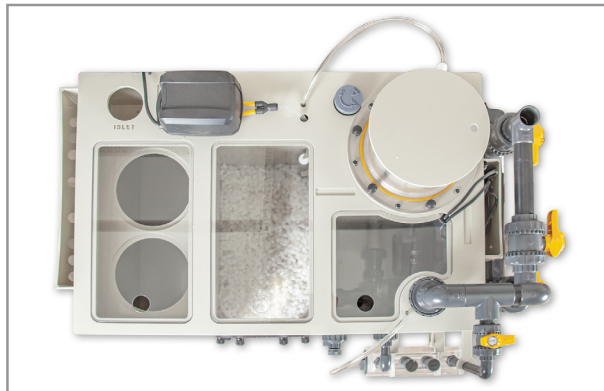

# TAILOR MADE RAS DESIGN & INSTALLATION

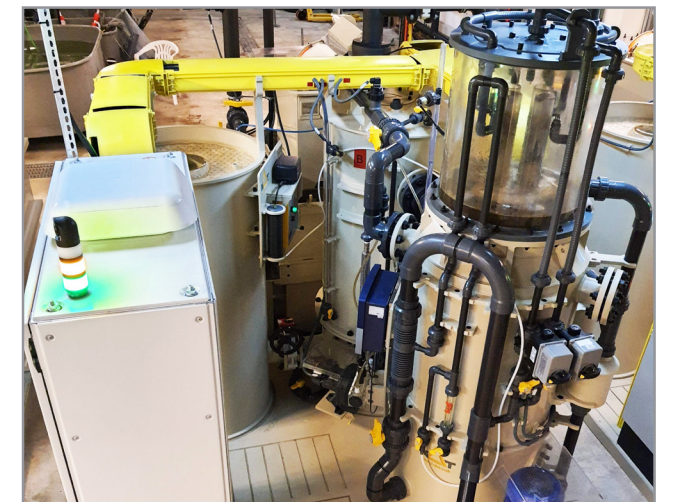



COMPACT FILTER	CPT-1	CPT-5	CPT-10
Footprint Depth C [mm]	700	975	1200
Footprint Width A [mm]	1020	1700	1900
Skimmer Diameter [mm]	200	315	400
Max Height B [mm]	750	1100	1950
Footprint with Sand/Glass Filter Depth [mm]	N/A	N/A	1235
Footprint with Sand/Glass Filter Width [mm]	N/A	N/A	2580
Installed Power [kW]	0.15	1.05	1.53
Basic Unit Total Electric Consumption [kWh]	0.15	0.74	1.07
Supply Voltage (50Hz) [V]	1~110-240	3~400/230	3~400/230
Max. Sump Level [mm]	370	525	865
Inlet Level [mm]	430	120	245
Inlet Size [mm]	50	63	110
Outlet Size [mm]	40	50	63
Overflow Connection Size [mm]	N/A	32	63
Compact Unit Nominal Flow [m <sup>3</sup> /hr]	1	4	10
Max. Allowable TDH after compact [m]	4.5	5	10
Max. Allowable TDH after compact with Sand/Glass filter [m]	N/A	N/A	7
Balance Water Volume [L]	53	142	330
Water Operation Level [mm]	345	370	580
TAN Removal Rate [gr TAN/day]	10	21	53
Canister Cartridge Volume [L]	N/A	2.1	7.45
Uv Disinfection Unit	UVC 1	UVC 5	UVC 10
Recommended Ozone Dosage [gr/h]	0.2	0.5	1
Pump Quantity [pcs]	2	2	2

CPT-20	CPT-30	CPT-40	CPT-75
1300	1700	1900	2470
2100	2700	3050	3580
482	630	750	950
2100	2400	2500	2810
1326	1685	approx. 2000	approx. 2600
2985	3995	approx. 4785	approx. 5586
2.12	4.1	4.5	10
1.48	2.87	3.15	7
3~400/230	3~400/230	3~400/230	3~400
930	985	1035	1190
255	260	260	265
125	140	160	225
63	75	75	110
63	63	63	75
20	30	40	75
9	10	9	12
12	20	29	50
530	940	1360	2750
600	615	620	640
76	162	263	540
13.5	18.5	30	50
UVC 20	UVC 50	UVC 50	UVC 100
2	3	5	10
2	2	2	2



COMPACT FILTER	CPT-1	CPT-5	CPT-10
PS/MBBR Pump Model	DC Runner ECO 6.0 (400-015-032)	44/4	21-40/53H
Circulation Pump Model	DC Runner 9.2	44/12	21-40/53G
Circulation Pump Model with Sand Filter	N/A	N/A	21-40/53H
Sand/Glass Filter Body Diameter [mm]	N/A	N/A	710
Total Sand Media Capacity kg	N/A	N/A	250
Total Glass Media Capacity GRADE-1 (kg)	N/A	N/A	125
Total Glass Media Capacity GRADE-2 (kg)	N/A	N/A	42
Total Glass Media Capacity GRADE-3 (kg)	N/A	N/A	42
Media Filter Valve Type	N/A	N/A	5-Way multiport valve
Dry Load [kg]	50	130	280
Operational Load [kg]	225	500	1250

CPT-20	CPT-30	CPT-40	CPT-75
21-40/54H	21-40/58	21-50/43	21-81/34
21-40/54G	21-40/58	21-50/43	21-81/34
21-40/54H	21-40/58	21-50/43	21-81/34
900	1000	1200	1400
450	700	1500	1950
225	350	750	975
75	117	250	325
75	117	250	325
5-Way multiport valve	5-Way multiport valve	5-Way multiport valve	5-Way multiport valve
330	560	630	1150
1725	3070	4265	7755

COMPACT FILTER OPTIONAL FEATURES	CPT-1	CPT-5	CPT-10
Carbon Media	N/A	Optional	Optional
Bag Filters	Optional	Optional	Optional
Bag filter Number [pcs]	2	3	4
Sand filter	N/A	N/A	Optional
Trickling media	N/A	Optional	Optional
MBBR Media	Optional	Optional	Optional
Sump Level Control	Optional	Optional	Optional
PS Overflow Switches	N/A	N/A	Optional
pH Probe	Optional	Optional	Optional
ORP Probe	Optional	Optional	Optional
Temperature Probe	Optional	Optional	Optional
Touch Screen Smart Transmitter For Probes	Optional	Optional	Optional
Foam Collector Autowash	N/A	Solenoid	Solenoid
External Fresh Water Line Valve For Autowash option	Motorized	Motorized	Motorized
Control Board	N/A	Optional	Optional
Control Board with PLC	N/A	Optional	Optional
Passive Ozon Destruct	N/A	Optional	Optional
PS Circulation and Distribution pump for Fresh water CPT	N/A	Optional	Optional
Makeup Water Automation	Optional	Optional	Optional

CPT-20	CPT-30	CPT-40	CPT-75
Optional	Optional	Optional	Optional
Optional	Optional	Optional	Optional
4	7	8	11
Optional	Optional	Optional	Optional
Optional	Optional	Optional	Optional
Optional	Optional	Optional	Optional
Optional	Optional	Optional	Optional
Optional	Optional	Optional	Optional
Optional	Optional	Optional	Optional
Optional	Optional	Optional	Optional
Optional	Optional	Optional	Optional
Optional	Optional	Optional	Optional
Optional	Optional	Optional	Optional
Optional	Optional	Optional	Optional
Solenoid	Solenoid	Solenoid	Solenoid
Motorized	Motorized	Motorized	Motorized
Optional	Optional	Optional	Optional
Optional	Optional	Optional	Optional
Optional	Optional	Optional	Optional
Optional	Optional	Optional	Optional
Optional	Optional	Optional	Optional
Optional	Optional	Optional	Optional
Optional	Optional	Optional	Optional



# AQUACULTURE TANKS



MAT-KULING produces aquaculture tanks from food grade Polypropylene with multiple customised features like sight windows, covers, net holders, bottom and overflow drains and pipe connection from 0.1m<sup>3</sup> to 200m<sup>3</sup>.

MAT-KULING designs and manufactures PP tanks in-house with 3D Models and CNC Automated cutting, bending and welding machines.



Aquaculture Fish Tank



Aquaculture Fish Tank



Aquaculture Fish Tank



Aquaculture Fish Tank



# AQUACULTURE TANKS



Square Quarantine Skid System



Pyramid Skid System

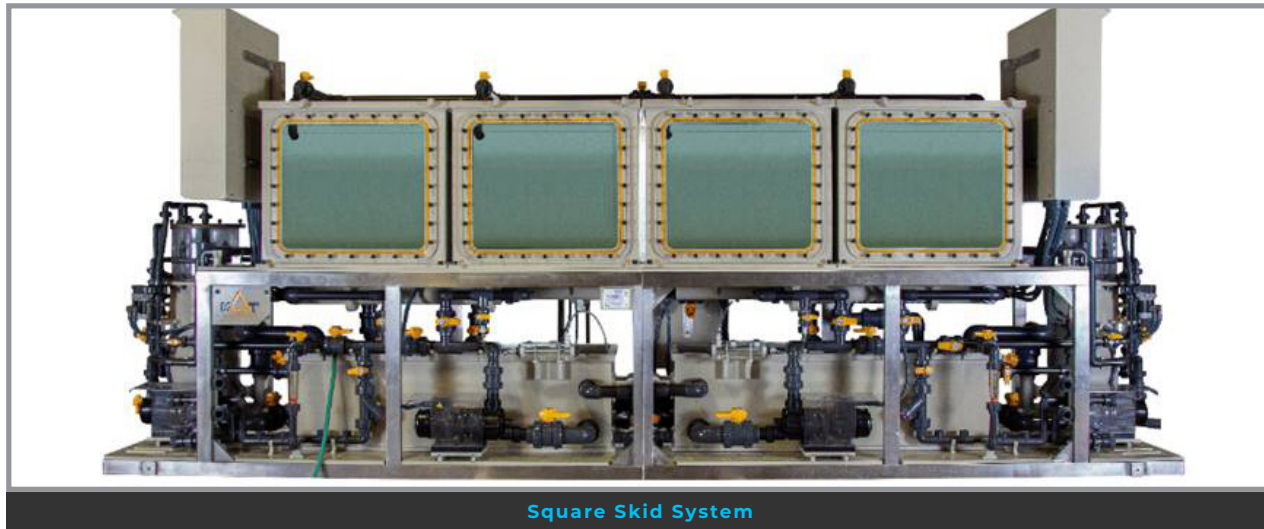

Square Skid System



QUARANTINE SKID	PYR-1	SQR-1	QRT-1
Footprint mm	2298	4500	1922
Footprint mm	1932	932	1295
Max. Height mm	1773	1930	1750
Skimmer Diameter mm	315	315	200
Total Electric Power kw	1,06	1,3	0,18
Power Supply	3~400/230V 50Hz	3~400/230V 50Hz	1~230V 50/60 Hz
Max Sump Level mm	525	375	1610
Skid Unit Nom. Flow m3/hr	4	4	1
TAN Removal Rate gr/d	21	21	10
Pump qty pcs	2	4	2
PS-MBBR Pump type	Badu 44/4	Badu 44/4	DC Runner ECO 6.0 (400-015-032)
Main Pump Model type	Badu 44/12	Badu 44/4	DC Runner 9.2
Dry-Weight kg	1180	700	245
Operational Weight kg	2100	2600	1360
UV Model	MAT UVC-5 L shaped	MAT UVC-5 L shaped	UVC 1
UV Radiation Rate J/m2	400	400	400
UV Lamp Power kW	87	87	40
Recommended Ozone Dosage g/h	0,5	1	0,2
Bag Filters pcs	4	8	2



## ARTEMIA HATCHING SYSTEMS



The Artemia Salina Hatching and Enrichment Module Tanks are an efficient hatching environment of Artemia salina cysts as well as a proper enrichment environment for Artemia salina Nauplii I and II.

The units provide accuracy and control of the hatching and enrichment conditions and offer excellent performance, bio secure hatching environment, stable hatching media physicochemical parameters, ease of operation and robust fabrication in a superior quality.

Artemia salina nauplii is used in aquariums, institutes, universities, laboratories, aquaculture and ornamental sector and is considered as a beneficial and nutritional food source at the critical larvae stages,



providing better survival rates and larvae quality.

The natural DHA and EPA resources of Artemia salina Nauplii, in addition with the Enrichment process in an absolute controlled environment guarantee the culture process.

The Artemia LFP Skid Systems include four pieces of single vessels mounted upon one table, where each vessel is 18,5lt.

Only one valve with a camlock is used for each vessel to collect the livestock and for drainage.



## ROTIFERS CULTURE SYSTEMS

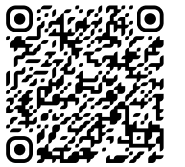

The Rotifers Live Feed Production Unit is designed to provide an efficient means of Rotifers culture and enrichment conditions, providing excellent performance, ease of operation and robust fabrication in a higher quality.

Live rotifers are used in aquariums and aquaculture and are generally considered nutritionally critical and necessary as a food source for marine organisms and more specific for their larvae stages.

The Rotifer Skid System consists of the vessel, the nutrition tank, the dosage pump, and the air stone. Three pieces of single vessels are mounted upon one table, where each vessel is of 17lt. The air stone is utilized to provide the necessary oxygenation by diffusing air into the ves-

sel. The air supply blower is an external part (not included) of the skid. Only one valve with a camlock is used for each vessel to collect the livestock and for drainage.

The MAT-KULING Rotifer Skid System offer excellent performance in Rotifer culture conditions distributing the Rotifer feed equally in every single point of the Unit, assisting the Rotifers to obtain their nutritional value.

The Rotifer Skid System provides a controlled physicochemical environment, culture and enrichment conditions of the Rotifer, which is vitally critical for the EPA and DHA nutritional value and better survival and quality of the larvae.

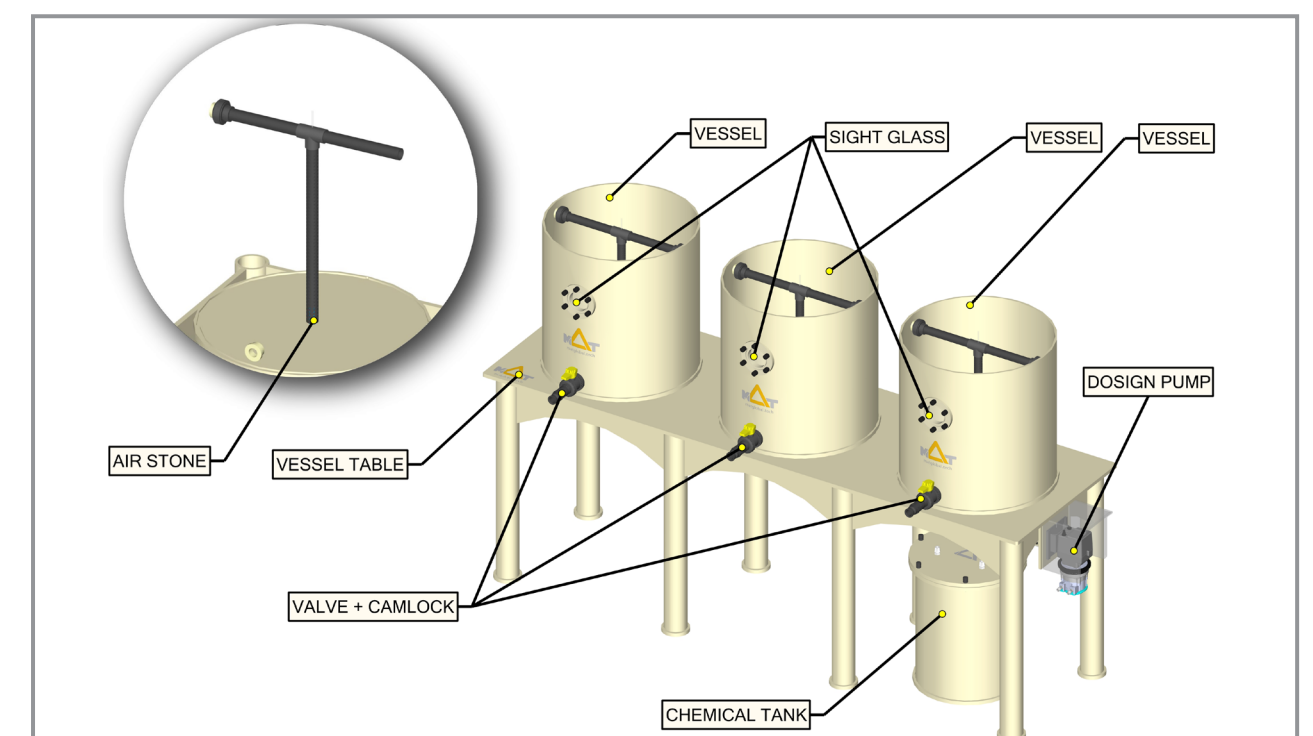

# COPEPODS CULTURE SYSTEMS



MAT-KULING Copepod Live Feed Production units are designed to provide an efficient means of Copepod reproduction, providing excellent performance, ease of operation and robust fabrication in a higher quality.

Live copepods are used in aquariums and aquaculture and are generally considered beneficial as a food source.

MAT-KULING Copepod LFP Skid includes



one vessel of 420lt and the sump of 450lt. Only two valves with camlock are used. The first one is used for livestock collection and drainage and is located on the sump.

The second one is used to transfer from the vessel to the sump.

SKID UNIT:	Artemia Reproduction Skid
Footprint Width mm	1800
Footprint Depth mm	600
Max. Height mm	1495
Table Height mm	640
Vessel Volume Lt	18,5
Camlock Valves qty pcs	1
Valve mm	32
Camlock Size in	1
SKID UNIT:	Rotifer Reproduction Skid
Footprint Width mm	2400
Footprint Depth mm	710
Max. Height mm	1510
Table Height mm	900
Vessel Volume Lt	158
Camlock Valves qty/vessel pcs	1
Valve mm	32
Camlock Size in	1
Chemical Tank	Standard

SKID UNIT:	Copepod Reproduction Skid
Footprint Width mm	900
Footprint Depth mm	900
Max. Height mm	2295
Table Height mm	1395
Copepod Vessel Diameter mm	800
Copepod Vessel Volume Lt	420
Sump Volume Lt	450
Camlock Valves qty pcs	2
Valve mm	32

Camlock Size in 1



# OXYGEN CONES



MAT OXC Oxygen Cone is a conical vessel designed to reinforce the process of oxygen gas mixing and saturation into the water.

The OXC is always paired with an oxygen supply device which provides the necessary oxygen gas quantity to be delivered to the mixing chamber.

The vessel is specially designed to achieve through a simple operation the best possible oxygen gas-water mixing.

The aquatic system's water along with in-fused oxygen are delivered on the top in-

let of the cone flowing downwards to the base with gradually reduced velocity as the vessel diameter increases.

Along this path the transferred stream of oxygen bubbles stream is continuously dissolving into the water until the complete saturation.



OPTIONAL FEATURES	OXC-10 - OXC-680
Oxygen Gas Pressure Gauge	Optional
Max Operational Pressure 4 Bar/Design Pressure 6 bar	Optional
Manuel Oxygen Gas Valve	Optional
Solenoid Oxygen Gas Valve	Optional
Oxygen Gas Pressure Sensor (-1 to 10 bar )	Optional
Oxygen Gas Flowmeter	Optional
Oxygen Gas Digital Flow Meter (Inline)	Optional
Oxygen Cone Pressure Gauge	Optional

OPTIONAL FEATURES	OXC-10 - OXC-680
Oxygen Cone Pressure Sensor (-1 to 9 bar)	Optional
Oxygen Cone Dissolved O2 Probe, DO2 Probe Fitting & Transmitter, Colourful Touchscreen panel	Optional
Oxygen Gas Inlet Automatic Solenoid Valve	Optional
Pressure Relief Valve	Optional

OXYGEN CONE MODEL	OXC-10	OXC-45
Diameter [mm]	300	600
Max. Height [mm]	970	1680
Inlet Size [DN]	40	80
Outlet Size [DN]	40	80
Max Water Flow [m <sup>3</sup> /h]	10	45
Max Water Flow [lt/m]	170	702
Standard Max. Operational/Design Pressure[bar]	2 / 3	2 / 3
High-Pressure Version Operational/Design Pressure[bar]	4 / 6	4 / 6
Oxygen Absorption 100% Sat 10°C @0,5bar Freshwater [kg/h]	0.17	0.66
Oxygen Absorption 100% Sat 10°C @1bar Freshwater [kg/h]	0.33	1.32
Oxygen Absorption 100% Sat 10°C @2bar Freshwater [kg/h]	0.66	2.64
Oxygen Absorption 100% Sat 10°C @3bar Freshwater [kg/h]	0.99	3.96
Oxygen Absorption 100% Sat 10°C @4bar Freshwater [kg/h]	1.32	5.28
Oxygen Absorption 100% Sat 15°C @0,5bar Freshwater [kg/h]	0.15	0.6
Oxygen Absorption 100% Sat 15°C @1bar Freshwater [kg/h]	0.3	1.2
Oxygen Absorption 100% Sat 15°C @2bar Freshwater [kg/h]	0.6	2.4
Oxygen Absorption 100% Sat 15°C @3bar Freshwater [kg/h]	0.9	3.6
Oxygen Absorption 100% Sat 15°C @4bar Freshwater [kg/h]	1.2	4.8
Oxygen Absorption 100% Sat 20°C @0,5bar Freshwater [kg/h]	0.14	0.54
Oxygen Absorption 100% Sat 20°C @1bar Freshwater [kg/h]	0.27	1.08
Oxygen Absorption 100% Sat 20°C @2bar Freshwater [kg/h]	0.54	2.16
Oxygen Absorption 100% Sat 20°C @3bar Freshwater [kg/h]	0.81	3.24
Oxygen Absorption 100% Sat 20°C @4bar Freshwater [kg/h]	1.08	4.32
Oxygen Absorption 100% Sat 25°C @0,5bar Freshwater [kg/h]	0.12	0.49
Oxygen Absorption 100% Sat 25°C @1bar Freshwater [kg/h]	0.24	0.97
Oxygen Absorption 100% Sat 25°C @2bar Freshwater [kg/h]	0.49	1.94
Oxygen Absorption 100% Sat 25°C @3bar Freshwater [kg/h]	0.73	2.916
Oxygen Absorption 100% Sat 25°C @4bar Freshwater [kg/h]	0.97	3.89
Maximum Oxygen Dosage Capacity (kg/h)	1.5	6
Oxygen Gas Connection Size (inch)	1/ 4 "	1/2 "
Cone Body Material	FRP	FRP

OXC-100	OXC-170	OXC-380	OXC-510	OXC-580	OXC-680
900	1200	1800	2000	2100	2200
2390	3100	4550	5300	5800	6250
150	150	250	315	350	400
150	150	250	315	350	400
100	170	380	510	580	680
1670	2840	6330	8500	9667	11333
2 / 3	2 / 3	2 / 3	2 / 3	2 / 3	2 / 3
4 / 6	4 / 6	4 / 6	4 / 6	4 / 6	4 / 6
1.49	2.64	5.5	7.43	8.17	8.98
2.97	5.28	11	14.85	16.63	18.46
5.94	10.56	22	29.7	33.26	36.92
8.91	15.84	33	44.55	49.9	55.38
11.88	21.12	44	59.4	66.53	73.85
1.35	2.4	5	6.75	7.43	8.17
2.7	4.8	10	13.5	15.12	16.78
5.4	9.6	20	27	30.24	33.57
8.1	14.4	30	40.5	45.36	50.35
10.8	19.2	40	54	60.48	67.13
1.22	2.16	4.5	6.08	6.68	7.35
2.43	4.32	9	12.15	13.61	15.1
4.86	8.64	18	24.3	27.22	30.21
7.29	12.96	27	36.45	40.82	45.35
9.72	17.28	36	48.6	54.43	60.42
1.09	1.94	4.05	5.47	6.01	6.62
2.19	3.89	8.1	10.94	12.25	13.59
4.37	7.776	16.2	21.87	24.49	27.19
6.56	11.66	24.3	32.81	36.74	40.78
8.75	15.55	32.4	43.74	48.99	54.38
13.5	24	50	67.5	75.6	83.92
1/2 "	3/4 "	3/4 "	1 "	1 "	1 "
FRP	FRP	FRP	FRP	FRP	FRP

\*\* O2 solubility in saline water = O2 solubility in freshwater × (1-0.005×salinity[ppt])



## DISSOLVED AIR FLOTATION (DAF)



Our DAF systems effectively remove total suspended solids (TSS), biochemical oxygen demand (BOD), and oils and greases (O&G) from wastewater by utilizing a dissolved air-in-water solution produced by injecting air under pressure into a recycle stream of clarified DAF effluent.

This solution is mixed with incoming wastewater, where the dissolved air forms micron-sized bubbles that attach to contaminants, facilitating their removal and achieving a reduction of total suspended solids by up to 90%, reducing the COD and obtaining a sludge dryness of around 6%.

MAT DAF system is an extensive surface flotation clarification unit with crossflow separation capabilities for sludge and water. Designed to handle wastewater streams heavily loaded with suspended solids and various impurities, this system provides a vast flotation area to effectively manage the separated sludge capable of processing up to 40 kg of dry matter per square meter.

### STANDARD FEATURES FOR DAF

- » DAF is made of a non-corrosive tank,
- » Skimmer
- » settling structure
- » sludge/water connections,
- » air supply, pneumatic panel, and air supply valve
- » recirculation pump.

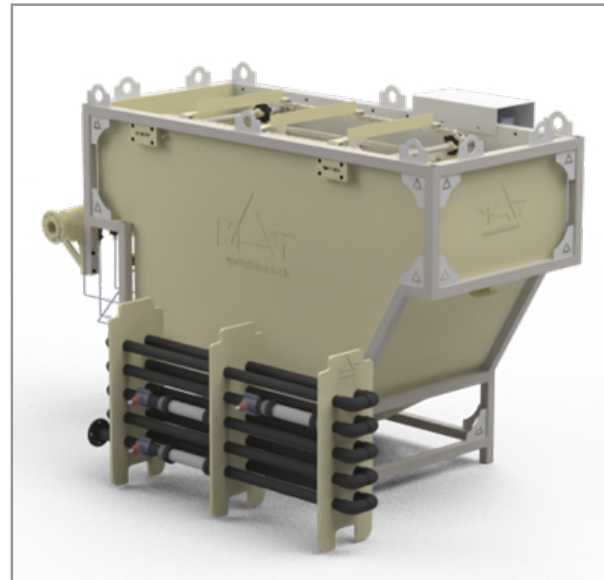

- » Lamella Plate Pack (only DAF-L models)

### OPTIONS FOR MAT DAF

- » Pressure (White Water Contact) Tank
- » Incorporated Skid-Mounted Flocculation Tubing: In-line flocculator —with Flocculant,
- » Coagulant, Costing dosing points, sampling and pH sensor taps.
- » Coagulant dosing pump.
- » Caustic soda dosing pump.
- » Flocculant (polyelectrolyte) preparation and dosing system.
- » pH sensor
- » Dosing Line Flowmeters
- » Sludge Pump
- » Sludge Screw Extractor
- » Flotation Tank Level Sensor

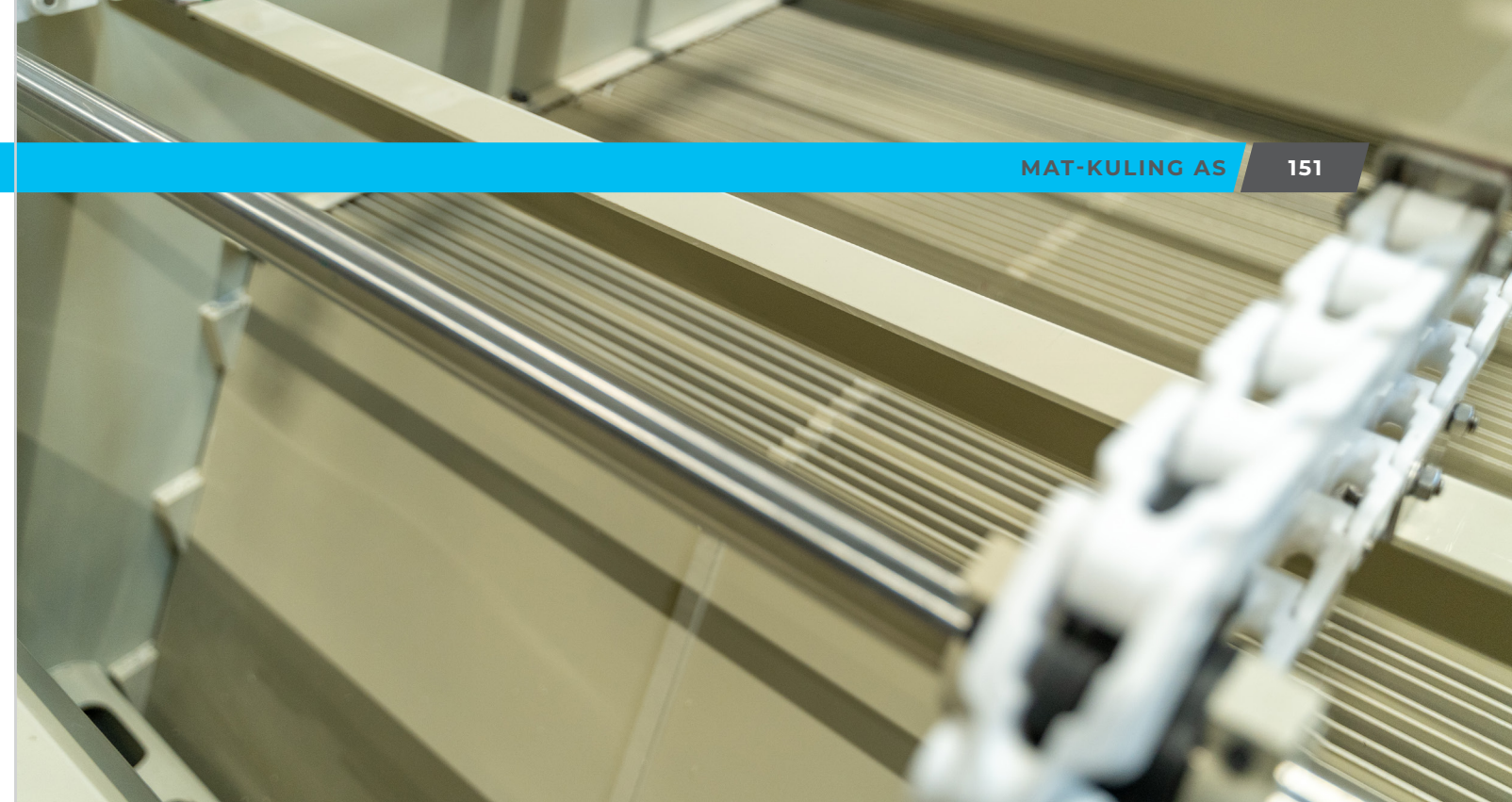

- » Process Flow Monitoring Sensor
- » Sludge Level Measurement
- » TSS (Total Suspended Solids) Monitoring in Inlet and Outlet
- » Smart Control Panel with Relay Logic and Microcontroller
- » PLC/HMI for operational flexibility
- » Access Platforms and Staircases
- » Flotation Tank Cover/Lid.

### BENEFITS OF MAT DAF

- » Pre-Assembled, Skid-Mounted Configuration - Delivers a ready-to-install setup, minimizing the need for on-site assembly.
- » Non-Corrosive Tank Construction from PP & PE: Engineered for durability - The tank is designed to resist flexing under operational stress. - Available in also 304, 316, and 316L Stainless Steel tank constructions.
- » Space-Efficient Design with Integrated

- » Plate Pack: - Ideal for space-constrained environments, offering compact and efficient use of space.
- » Uniform High-Quality Production and Advanced Manufacturing: -Ensures consistent and superior product quality, leveraging cutting-edge production technology.
- » Streamlined Flow for Enhanced Separation Efficiency: - Improves the effectiveness of the separation process, leading to better contaminant removal.
- » Efficient Rectangular Design: - Maximizes space utilization with its compact rectangular shape.
- » High-Quality Drive and Pump Components: -Ensures long-term dependability with premium quality components.
- » Customization Options Available with Minimal Effect on Delivery Timelines or Costs

MODEL	DAF-5	DAF-10	DAF-20
Annual Hydraulic Capacity [m <sup>3</sup> /h]	5	10	20
Annual Hydraulic Loading Rate[m/h]	4	4	4
Free Flotation Area[m <sup>2</sup> ]	1.25	2.5	5
Lamella Surface Area[m <sup>2</sup> ]	N/A	N/A	N/A
Solid Loading Rate Range[kg/h/m <sup>2</sup> ]	25-45	25-45	25-45
A/S - Air-Solid Ratio Range[kg/kg]	0.01 - 0.06	0.01 - 0.06	0.01 - 0.06
Flotation Tank Length[mm]	2500	3150	5000
Flotation Tank Height[mm]	1400	1500	2300
Flotation Tank Width[mm]	1900	2000	2400
Empty Flotation Tank Weight[kg]	520	1250	2200
Full Flotation Tank Weight[kg]	1600	3300	11500
Flotation Tank Material-	PP	PP	PP
Skimmer Motor Power[kW]	0.4	0.4	0.4
Recirculation Pump Annual Flow[m <sup>3</sup> /h]	1.25	2.5	5
Recirculation Water Annual Pressure[Bar]	4.0-6.0	4.0-6.0	4.0-6.0
Recirculation Pump Motor Power[kW]	5.5	5.5	7.5
Pressurized Tank Volume[l]	62.5	125	250
Annual Pressurized Tank Contact Time[min.]	3	3	3
Required Compressed Air Pressure[Bar]	6.0-8.0	6.0-8.0	6.0-8.0
Required Normal Air Flow[Nm <sup>3</sup> /h]	11	21	42
Inlet Connection[DN]	65	80	100
Effluent Connection[DN]	65	80	100
Float Discharge Connection[DN]	80	80	80
Settled Solid Discharge Connection[DN]	50	50	50

DAF-35	DAF-50	DAF-100	DAF-150	DAF-200
35	50	100	150	200
4	4	4	4	4
8.8	12.5	25	38	50
N/A	N/A	N/A	N/A	N/A
25-45	25-45	25-45	25-45	25-45
0.01 - 0.06	0.01 - 0.06	0.01 - 0.06	0.01 - 0.06	0.01 - 0.06
7000	8000	9500	14000	17000
2300	2300	2300	2300	2300
2300	2400	3400	3400	3400
2500	2800	4700	5400	6400
14000	17000	29500	42000	53800
PP	PP	PP	PP	PP
0.4	0.6	0.6	0.6	0.6
8.75	12.5	25	37.5	50
4.0-6.0	4.0-6.0	4.0-6.0	4.0-6.0	4.0-6.0
7.5	11	15	15	15
437.5	625	1250	1875	2500
3	3	3	3	3
6.0-8.0	6.0-8.0	6.0-8.0	6.0-8.0	6.0-8.0
73	104	208	312	416
125	150	200	250	300
125	150	200	250	300
100	100	125	150	200
65	80	100	125	150



MODEL	DAF-5	DAF-10	DAF-20
Pressurized Air Connection[inch]	1/2"	1/2"	3/4"
Sludge Screw Power[kW]	N/A	N/A	0.4
Sludge Pump Power[kW]	0.5	0.5	N/A
Inline Flocculator Model-	IPF-5	IPF-10	IPF-20
Standard Flocculator Tube Material -	U-PVC/PP/PE	U-PVC/PP/PE	U-PVC/PP/PE
Flocculator Tube Diameter [DN]	63	75	90
Flocculator Total Tube Length [m]	20	30	40
Coagulant Dosage Pump Capacity[l/h]	5	10	20
Coagulant Tank Model-	CDS-500	CDS-500	CDS-1000
Coagulant Tank Volume[l]	500	500	1000
Caustic Dosage Pump Capacity[l/h]	3.5	7	14
Caustic Tank Model-	CDS-200	CDS-500	CDS-1000
Caustic Tank Volume[l]	200	500	1000
Flocculant (polyelectrolyte) preparation and dosing System Model -	PPS-500	PPS-1000	PPS-1500

DAF-35	DAF-50	DAF-100	DAF-150	DAF-200
3/4"	1"	1 1/2"	2"	2 1/2"
0.4	0.4	0.6	0.6	0.6
N/A	N/A	N/A	N/A	N/A
IPF-35	IPF-50	IPF-100	IPF-150	IPF-200
U-PVC/PP/PE	U-PVC/PP/PE	U-PVC/PP/PE	U-PVC/PP/PE	U-PVC/PP/PE
110	110	160	200	200
45	62	62	62	80
35	50	100	150	200
CDS-1000	CDS-2000	CDS-2000	CDS-3000	CDS-4000
1500	2000	2000	3000	4000
24.5	35	70	105	140
CDS-1000	CDS-1500	CDS-2000	CDS-3000	CDS-4000
1000	1500	2000	3000	4000
PPS-2000	PPS-3000	PPS-4000	PPS-4000	PPS-5000

MODEL	DAF 5-L	DAF 10-L	DAF 20-L
Annual Hydraulic Capacity [m <sup>3</sup> /h]	5	10	20
Annual Hydraulic Loading Rate[m/h]	6.7	6.7	7.2
Free Flotation Area[m <sup>2</sup> ]	0.45	0.9	1.6
Lamella Surface Area[m <sup>2</sup> ]	0.3	0.6	1.2
Solid Loading Rate Range[kg/h/m <sup>2</sup> ]	10.0-30.0	10.0-30.0	10.0-30.0
A/S - Air-Solid Ratio Range[kg/kg]	0.01 - 0.06	0.01 - 0.06	0.01 - 0.06
Flotation Tank Length[mm]	1200	2200	3000
Flotation Tank Height[mm]	2100	2100	2100
Flotation Tank Width[mm]	1400	1400	1400
Empty Flotation Tank Weight[kg]	450	700	950
Full Flotation Tank Weight[kg]	1600	2800	5200
Flotation Tank Material-	PP	PP	PP
Skimmer Motor Power[kW]	0.4	0.4	0.4
Recirculation Pump Annual Flow[m <sup>3</sup> /h]	0.75	1.5	3
Recirculation Water Annual Pressure[Bar]	4.0 -6.0	4.0 -6.0	4.0 -6.0
Recirculation Pump Motor Power[kW]	5.5	5.5	5.5
Pressurized Tank Volume[l]	37.5	75	150
Annual Pressurized Tank Contact Time[min.]	3	3	3
Required Compressed Air Pressure[Bar]	6.0-8.0	6.0-8.0	6.0-8.0
Required Normal Air Flow[Nm <sup>3</sup> /h]	7	14	28
Inlet Connection[DN]	65	80	100
Effluent Connection[DN]	65	80	100
Float Discharge Connection[DN]	80	80	80
Settled Solid Discharge Connection[DN]	50	50	50

DAF 35-L	DAF 50-L	DAF 100-L	DAF 150-L	DAF 200-L
35	50	100	150	200
7.2	7.2	7.2	7.2	7.2
2.8	4	7.3	11.6	15.2
2.1	3	6.6	9.5	12.7
10.0-30.0	10.0-30.0	10.0-30.0	10.0-30.0	10.0-30.0
0.01 - 0.06	0.01 - 0.06	0.01 - 0.06	0.01 - 0.06	0.01 - 0.06
3000	3750	5000	5500	6500
2700	2700	4000	4000	4000
1900	2400	2400	3400	3400
1200	1550	2300	3300	4300
6500	9200	15000	19250	25500
PP	PP	PP	PP	PP
0.4	0.6	0.6	0.6	0.6
5.25	7.5	15	22.5	30
4.0 -6.0	4.0 -6.0	4.0 -6.0	4.0 -6.0	4.0 -6.0
7.5	7.5	11	11	15
262.5	375	750	1125	1500
3	3	3	3	3
6.0-8.0	6.0-8.0	6.0-8.0	6.0-8.0	6.0-8.0
49	70	139	208	278
125	150	200	250	300
125	150	200	250	300
100	100	125	150	200
65	80	100	125	150



MODEL	DAF 5-L	DAF 10-L	DAF 20-L
Pressurized Air Connection[inch]	1/2"	1/2"	1/2"
Sludge Screw Power[kW]	N/A	N/A	N/A
Sludge Pump Power[kW]	0.5	0.5	0.5
Inline Flocculator Model-	IPF-5	IPF-10	IPF-20
Standard Flocculator Tube Material -	U-PVC/PP/PE		
Flocculator Tube Diameter [DN]	63	75	90
Flocculator Total Tube Length [m]	20	30	40
Coagulant Dosage Pump Capacity[l/h]	5	10	20
Coagulant Tank Model-	CDS-500	CDS-500	CDS-1000
Coagulant Tank Volume[l]	500	500	1000
Caustic Dosage Pump Capacity[l/h]	3.5	7	14
Caustic Tank Model-	CDS-200	CDS-500	CDS-1000
Caustic Tank Volume[l]	200	500	1000
Flocculant (polyelectrolyte) preparation and dosing System Model -	PPS-500	PPS-1000	PPS-1500

DAF 35-L	DAF 50-L	DAF 100-L	DAF 150-L	DAF 200-L
3/4"	3/4"	1"	1 1/2"	2"
0.4	0.4	0.4	0.4	0.6
N/A	N/A	N/A	N/A	N/A
IPF-35	IPF-50	IPF-100	IPF-150	IPF-200
110	110	160	200	200
45	62	62	62	80
35	50	100	150	200
CDS-1000	CDS-2000	CDS-2000	CDS-3000	CDS-4000
1500	2000	2000	3000	4000
24.5	35	70	105	140
CDS-1000	CDS-1500	CDS-2000	CDS-3000	CDS-4000
1000	1500	2000	3000	4000
PPS-2000	PPS-3000	PPS-4000	PPS-4000	PPS-5000

# RADIAL FLOW SETTLER (RFS)

The Radial Flow Settler (RFS) is highly cost effective in reducing solids loading in a system and operates passively, requiring no additional energy. This low-maintenance equipment is designed for routine cleaning only, with no need for extra servicing or repairs. Available in various sizes to accommodate different flow requirements, the RFS is also optimized for containerized shipping, making it accessible for worldwide use.

The MAT-KULING Radial Flow Settler (RFS) is an efficient solution for removing particulates from effluent water in various industrial applications. The system works by directing the water into the RFS Liquid Inlet, where it flows upward through the adjustable Standpipe Assembly and down through the Stilling Well. During this pro-

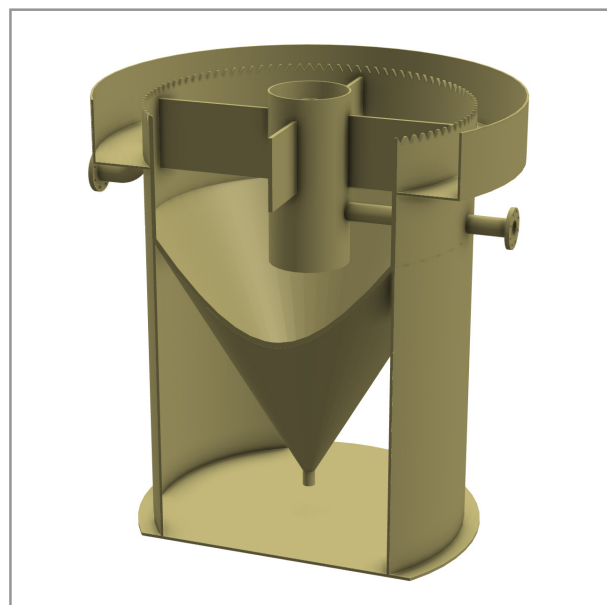
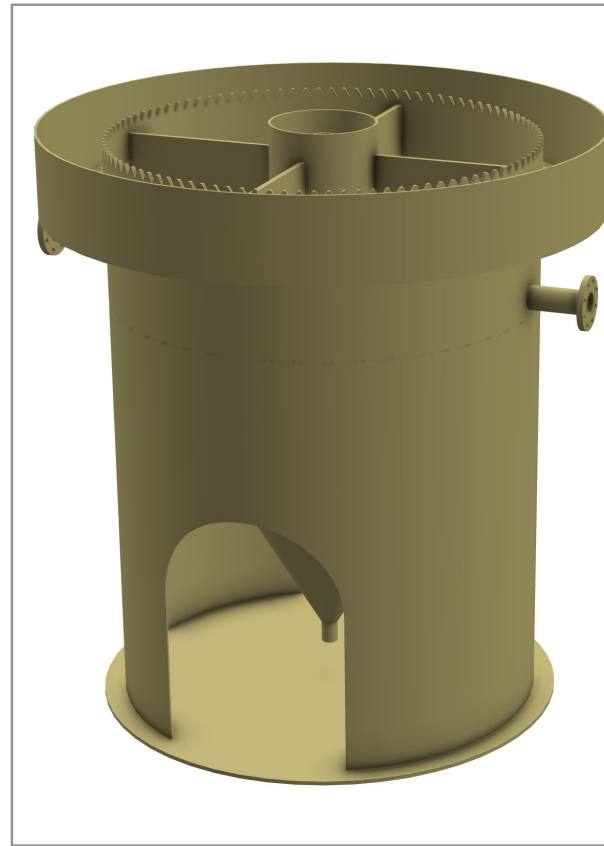

cess, solid particulates naturally settle to the cone bottom and are easily removed via the Solids Outlet. The filtered water then rises over a V-Notch Weir into the Launder and exits through the Liquid Outlet, ensuring cleaner and safer water discharge.

MODEL	RFS-315-45	RFS-315-60	RFS-500-45	RFS-500-60	RFS-610-45	RFS-610-60	RFS-750-45	RFS-750-60
Diameter (mm)	315	315	500	500	610	610	750	750
Max. Flow (@0.003 m/s) (m3/h)	0.78	0.78	1.97	1.97	2.93	2.93	4.42	4.42
Average. Flow (@0.0015 m/s) (m3/h)	0.39	0.39	0.98	0.98	1.46	1.46	2.21	2.21
Stilling Well Diameter (mm)	80	80	130	130	160	160	200	200
Stilling Well Length (mm)	350	350	370	370	390	390	410	410
Launder Width (mm)	90	90	90	90	110	110	110	110
Launder Depth (mm)	300	300	300	300	300	300	300	300
Net Settling Area (m2)	0.07	0.07	0.18	0.18	0.27	0.27	0.41	0.41
Max. OD. (mm)	600	600	700	700	900	900	1000	1000
Inlet Connection Size (mm)	32	32	40	40	50	50	63	63
Outlet Connection Size (mm)	40	40	50	50	63	63	75	75
Sludge Connection Size (mm)	32	32	40	40	50	50	50	50
Cone Angle°	45	60	45	60	45	60	45	60
Max. Height (mm)	1300	1550	1400	1700	1470	1767	1552	1916



MODEL	RFS-1100-45	RFS-1100-60	RFS-1600-45	RFS-1600-60	RFS-1900-45	RFS-1900-60	RFS-2200-45	RFS-2200-60	RFS-2500-45
Diameter (mm)	1100	1100	1600	1600	1900	1900	2200	2200	2500
Max. Flow (@0.003 m/s) (m <sup>3</sup> /h)	9.68	9.68	20.34	20.34	28.65	28.65	38.37	38.37	49.62
Average. Flow (@0.0015 m/s) (m <sup>3</sup> /h)	4.84	4.84	10.17	10.17	14.32	14.32	19.18	19.18	24.81
Stilling Well Diameter (mm)	260	260	400	400	480	480	560	560	630
Stilling Well Length (mm)	440	440	500	500	550	550	580	580	620
Launder Width (mm)	110	110	150	150	180	180	220	220	220
Launder Depth (mm)	300	300	300	300	300	300	300	300	400
Net Settling Area (m <sup>2</sup> )	0.89	0.89	1.88	1.88	2.65	2.65	3.55	3.55	4.59
Max. OD. (mm)	1300	1300	1900	1900	2200	2200	2500	2500	2800
Inlet Connection Size (mm)	75	75	90	90	110	110	125	125	140
Outlet Connection Size (mm)	90	90	110	110	125	125	140	140	160
Sludge Connection Size (mm)	63	63	63	63	75	75	75	75	90
Cone Angle°	45	60	45	60	45	60	45	60	45
Max. Height (mm)	1817	2279	2543	3137	2708	3534	2939	3699	2972

RFS-2500-60	RFS-2800-45	RFS-2800-60	RFS-3000-45	RFS-3000-60	RFS-3400-45	RFS-3400-60	RFS-4300-45	RFS-4300-60	RFS-5500-45	RFS-5500-60
2500	2800	2800	3000	3000	3400	3400	4300	4300	5500	5500
49.62	62.31	62.31	70.87	70.87	91.13	91.13	146.49	146.49	239.84	239.84
24.81	31.15	31.15	35.43	35.43	45.56	45.56	73.24	73.24	119.92	119.92
630	700	700	800	800	900	900	1100	1100	1400	1400
620	650	650	700	700	730	730	850	850	1000	1000
220	240	240	290	290	300	300	360	360	440	440
400	400	400	500	500	600	600	700	700	800	800
4.59	5.76	5.76	6.56	6.56	8.43	8.43	13.56	13.56	22.2	22.2
2800	3200	3200	3500	3500	3800	3800	4800	4800	6000	6000
140	160	160	200	200	200	200	315	315	355	355
160	250	250	280	280	315	315	355	355	400	400
90	90	90	110	110	110	110	125	125	140	140
60	45	60	45	60	45	45	60	45	60	60
4029	3137	4359	3269	4623	3468	4953	3798	5614	4128	6274

# GATE VALVES



MAT-KULING produces Gate Valves from a thermo-plastic material to ensure a corrosion-free solution for facilities up to D700mm flange size up to 3 Bar Nominal operational pressure.

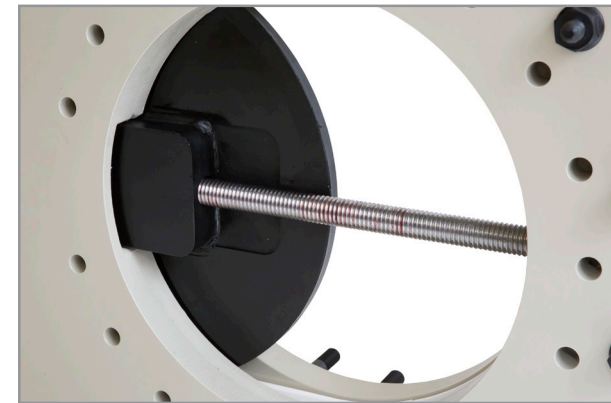
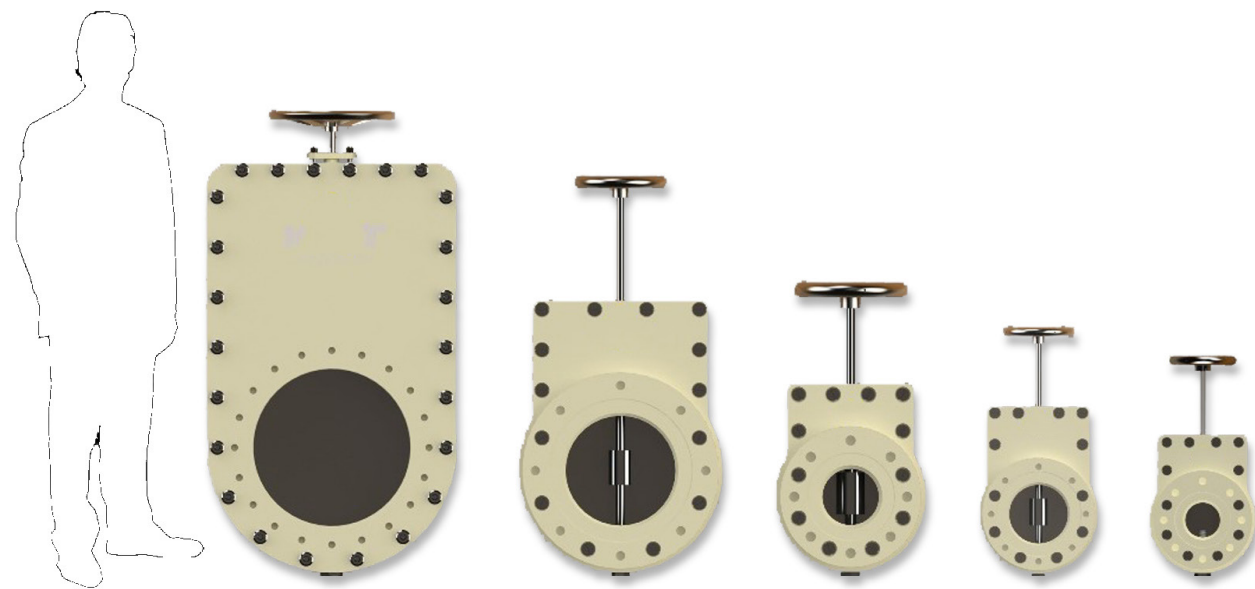



GATE VALVE	GTV-75	GTV-90	GTV-110	GTV-125	GTV-140	GTV-160	GTV-200	GTV-225
Height mm	412	417	450	500	553	600	693	770
Width mm	170	180	196	224	230	280	304	392
Thickness mm	88	88	88	88	88	108	108	108
Diameter mm	75	90	110	125	140	160	200	225
Body Material	PP	PP	PP	PP	PP	PP	PP	PP
Shaft Material	Titanium/316L							
Operational Pressure kg/cm <sup>2</sup>	2	2	2	2	2	2	2	1,5
Corrosion Resistance (salt water/ fresh water)	Salt/fresh							
Flange Connection	EN1452-3							
Weight kg	3,5	3,5	4	4,5	5	8	11	16
Test Pressure kg/cm <sup>2</sup>	3	3	3	3	3	3	3	2
Titanium/316Ti/ SuperDuplex Spindle	optional							
316L Stem Length Extension=1m	optional							
Titanium/316Ti/ SuperDuplex Stem Length Extension=1m	optional							

GTV-250	GTV-280	GTV-315	GTV-355	GTV-400	GTV-450	GTV-500	GTV-630	GTV-750	GTV-1000
880	990	1100	900	1000	1150	1483	2150	2640	3465
448	504	560	620	700	720	800	1100	1344	1764
108	108	120	120	150	200	200	240	288	378
250	280	315	355	400	450	500	630	750	1000
PP	PP	PP	PP	PP	PP	PP	PP	PP	PP
Titanium/316L									
1,5	1,5	1,5	1	1	1	0,5	0,5	0,5	0,5
Salt/fresh									
EN1452-3									
21	28	40	75	90	120	160	200	220	300
2	2	2	2	2	2	1	1	1	1
optional									
optional									
optional									



# MAT-KULING AS

NORWEGIAN RAS INNOVATION





VIEW THE LATEST VERSION  
OF THIS CATALOG ONLINE

*Scan me!*



[matkuling.com](http://matkuling.com)







## MAT-KULING AS

Web: [matkuling.no](http://matkuling.no)

Phone: (+47) 90 86 53 01

Email: [info@matkuling.no](mailto:info@matkuling.no)